



सीईएसआईआर-केन्द्रीयवैज्ञानिकउपकरणसंगठन  
CSIR-Central Scientific Instruments Organisation  
सैक्टर 30 सीचंडीगढ़Sector-30C, Chandigarh 160 030

ई-मेल / e-mail: [harry.garg.csio@csir.res.in](mailto:harry.garg.csio@csir.res.in)

ई-मेल /रजिस्टर्ड/ स्पीड पोस्ट/ कूरिएर द्वारा

एल.पी.सी.एन.आई.टी.सं./LPC NIT No.:	CSIO/IMW/FB/25-05-26/01
दिनांक / Date:	26.05.2026
निविदाप्राप्तिकांतिमसमयएवंदिनांक / Date & time of receipt of tender	31.05.2026 (05.00 pm)

महोदय/Sir,

हम उपस्कर/सामग्री खरीदनेके इच्छुक हैं। इससे सम्बंधित नियम व शर्तेंव अन्य दस्तावेज संलग्न हैं./We are interest to purchase the below given items/attached items for R&D purpose. The terms and conditions and other documents are attached herewith-

S. No.	Item Name with Complete Specification	Quantity
1.	<b>FABRIICATION MIL GRADE NYLON, , FITMENT OF HOUSING, ONSITE TESTING, INSTALLATION AS PER DWGS</b>	AS PER DA(TA SHEET, DWGS ATTACHEMENT

एकल बोली प्रणाली में मुहरबंद निविदाएं आमंत्रित की जाती हैं। कवर के ऊपर , स्थानीय खरीद समिति (एल पी सी) की एन आई टी, एलपीसी एनआईटी संख्या, नियत तिथि, खोलने की तिथि अंकित होनी चाहिए और निदेशक, सी. एस. आई. आर. -केन्द्रीय वैज्ञानिक उपकरण संगठन, सेक्टर- 30 सी, चंडीगढ़-160030तथा ध्यान-आकर्षण--- प्रमुख, नाम और पदनामको संबोधित होनी चाहिए । मुहरबंद कवर में निम्नलिखित शामिल हैं। बोली ई-मेल के द्वारा भी भेजी जा सकती है । /The sealed tenders are invited in **Single bid system**. Cover shall be superscribed with **NIT of Local Purchase Committee, LPC NIT no., Due date, Date of opening** and addressed to the **Director, CSIR-Central Scientific Instruments Organisation, Sector- 30 C, Chandigarh-160030** and also mentioned-; The Sealed cover contains the followings.

**The bid/quotation may also be submitted through E-mail to [harry.garg.csio@csir.res.in](mailto:harry.garg.csio@csir.res.in)**

Documents/Papers to be submitted with Bid: **(In the absence of these, bid/Quotation will be summarily rejected).**

Sl. No.	Documents required
A.	Duly filled, signed and stamped Bid Securing Declaration (BSD) as per <b>Annexure - I</b>
B.	Self-attested copy of duly Signed and stamped <b>Manufacturer's Authorization Form (Annexure-II)</b> (In case the bids have been submitted by the Authorized Dealer/Distributor).
C.	Duly filled, signed and stamped Tender acceptance letter as per format <b>Annexure - III</b>
D.	Duly filled, signed and stamped Code of Integrity as per format <b>Annexure - IV</b>
E.	Duly filled, signed and stamped Certificate of Price Reasonability as per <b>Annexure V</b>
F.	<b>Technical Bid along with Technical Literature Document</b> – self attested copies of technical literature of item(s) with details of specifications.
G.	A copy of <b>self- certification</b> about the products offered in this tender meets local content requirement for <b>Class- I Local supplier (local content minimum 50%)</b> or <b>Class- II Local supplier (local content minimum 20%)</b> or <b>Non- Local supplier (local content less than 20%)</b> as per <b>Make in India Policy No. P-45021/2/2017-PP(BE-II) dt- 16/09/2020</b> .The details of the <b>location(s)</b> at which the local value addition is made should also be mentioned in the self-certification as per <b>Annexure – VI</b> .
H.	A copy of certificate (a model certificate is given in the attached) regarding <b>Restrictions on procurement from a bidder of a country which shares a Land Border with India</b> wherein if any bidder from a country which shares a land border with India will be eligible to bid in any procurement whether of goods, services or work only if the bidder registered with the competent authority as per <b>Annexure - VII</b>
I.	Copy of duly filled, signed and stamped Bank account details of the firm on their letter head as per our format as per <b>Annexure - VIII</b>
J.	Duly filled, signed and stamped <b>Price Schedule (in INR only)</b> as per <b>Annexure - IX</b>

निविदा प्रस्तुत करने से पहले, कृपया संलग्न नियमों और शर्तों को ध्यान से पढ़ें, जिन पर निविदाएं अवार्ड की जाएंगी और सफल बोलीदाता द्वारा कार्यान्वित किया जाएगा।/ Before submitting the quotation/ bid, please go through the enclosed terms and conditions on which the purchase order will be awarded and shall be executed by the successful bidder.

(\_\_\_\_\_)

For & on behalf of CSIR-CSIO

संलग्न/Encl.:

1. नियम एवं शर्तें/ Terms & Conditions
2. अनुलग्नक-I से IX तक /Annexure- I to IX

## नियम और शर्तें / Terms & Conditions

1. The quotation/bid must be in the form furnished by the Purchaser/as per tender specifications and should be free from corrections/erasures. In case there is any unavoidable correction it should be properly attested. If not, the quotation will not be considered. Please refer our complete tender terms & conditions. Ensure to provide the required documents to avoid rejection.
2. The rates should be in **INR only** and also on FOR.CSIO, Chandigarh (Central Stores) basis. Where there is no mention of packing, forwarding, freight, insurance charges, taxes etc. **such offer shall be rejected as incomplete**. The bidder should also give a clear cut break up of quoted price to facilitate the proper comparison **failing which the bid would be summarily ignored/rejected**. **Our GST No. is 04AAATC2716R1ZN**
3. The Bidder is expected to examine all instructions, forms, terms & conditions, and specifications in the NIT documents. Failure to furnish all information required by the bidding documents or submission of a bid not substantially responsive to the bidding documents in every respect will be at the Bidder's risk and may result in rejection of its bid.
4. The quotations/ bids will be accepted through offline (Indian post/ courier) preferably as well as through e-mail. If the quotation is submitted through E-mail, then bidder should attach scan copies of all duly filled, signed and stamped required documents (mandatory & others). The tender received in any other mode will not be accepted and will be ignored. It may kindly be noted that your bid should contain all the mandatory documents as mentioned in NIT. **If not, the bid will be summarily rejected.**
5. Bid/ Quotation received after due date and time will not be accepted under any circumstances.
6. On the event of award of purchase order in your favour, you need to submit a **Performance Bank Guarantee (PBG)** valid for a period of 60 days beyond the Warranty period of.....(retain only, if applicable). **In case of all capital items (equipment, machine etc) costing above 2.5 lakh rupees, the successful bidder will have to submit PBG (@3% of total value) within 21 days from the date of issuing purchase order.**
7. The acceptance of the quotation will rest with the competent authority of **Central Scientific Instruments Organisation, Sector-30, Chandigarh** who does not bind himself to accept the lowest quotation and reserves the right to himself to reject, or partially accept any or all the quotations received without assigning any reason.
8. **Bid Validity:** Bid should be valid for a minimum period of **90 days** from the date of opening of the quotation, **failing which the offer will be ignored/rejected**.
9. The bidder must submit the Price Schedule as per Annexure-X.
10. Technical bid alongwith Technical Literature/Pamphlets should also be enclosed wherever applicable **and only mentioning "YES" in Questionnaire about fulfilling the parameters of specifications will be treated as incomplete and bid will not be accepted**. Complete specification with manufacturer's name and address should be given while quoting.
11. Prices are required to be quoted in units indicated in the enquiry. When quotations are given in terms of other units, relationship between two sets of units should be furnished. Quantity discounts, if any should also be indicated. The items should be quoted indicating the serial No. of our RFQ/NIT.
12. In cases of quoting on behalf of Indian Manufacturer, one dealer/stockist cannot represent two manufacturers or quote on their behalf in a particular tender enquiry. One manufacturer can also authorize only one stockist/dealer. There can be only one bid from the Indian authorised dealer on behalf of only one principal/manufacturer.
13. **Taxes as are applicable should be indicated clearly failing which the offer shall not be considered and rejected**. This lab is registered with Dept. of Scientific & Industrial Research, Govt. of India and concessional GST & IGST are levy able vide Govt. Notification No. 45/2017-Central Tax (rate) & No. 45/2017-Integrated Tax (rate) dated 14.11.2017 for R& D products. **No Custom duty exemption certificate will be given in any case.**
14. **Delivery period** required for supplying the material should be invariably specified in the quotation. The offered delivery period shall have to be strictly adhered to in case an order is placed.
15. **Liquidated Damages Clause for delays:** The applicable rate is 0.5% per week and maximum deduction is 10% of the contract price. **Installation/commissioning:** Equipment/Instruments are required to be

commissioned/installed/ demonstrated successfully immediately or within 30 days from the date of receipt of the system in CSIO by the manufacturer or by their authorized Agent, **failing which the Liquidated Damage Clause will be applicable as mentioned** above.

16. If the deliveries are not maintained and due to that account, the purchaser is forced to buy the material at your risk and cost from elsewhere, the loss or damage that may be sustained there by will be recovered from the defaulting supplier.
17. **Warranty Period:** Please mention the warranty period of equipment, which should be from the date of satisfactory installation. **The offer received for lesser warranty, as asked for in the tender, will be rejected/ignored.** All supplies are subject to inspection and approval before acceptance. Manufacturer warranty certificates and manufacturer/Government approved lab test certificate shall be furnished along with the supply, wherever applicable.
18. **Terms of Payment:** Our payment terms are 100% (hundred percent) within 30 (thirty) days on receipt, acceptance, installation & commissioning (if required), training (if required) and confirmation of PBG (if required) of material at our site in good condition. Please inform your Bank details as per our format for RTGS payment. Banking details should be available on Bill/invoice. **Advance payment will be not given in any condition.** Other mode of payment may be decided by the by the Committee with the approval of the Director. **Should furnish your PAN & GST Number in your quotation & on Invoice. TDS would be recovered as per rules.**
19. **Reasonability of Prices/Fall Clause**
  - I. Quote best minimum prices applicable for a CSIO, Research Institution, leaving no scope for any further negotiations on prices.
  - II. **The quoting party should give a certificate to the effect that the quoted prices are the minimum and they have not quoted the same item on lesser rates than those being offered to CSIO to any other customer nor they will do so till the validity of offer or execution of the purchase order, whichever is later.**
  - III. Copies of at least two recently supplied orders of the last two years received from other customers alongwith details of such supply orders in India for the same item/model may be submitted with the offer giving reasons of price difference of their supply order & those quoted to us, if any. The party must give details of identical or similar equipment, if any, supplied to any CSIR lab during the last three years alongwith the final price paid and Performance certificate from them.
20. Certificate of undertaking that the equipment is of latest technology & will not be obsolete within 5 years after warranty will be attached with the offer. All essential spares parts of the offered equipment will available with the manufacturer for a period of at least 5-7 years after warranty period which will be required at later stage.
21. **MSME purchase preferences** will be given to the eligible supplier as per the Govt. guidelines subject to submission of proper document as per policy or Udyog Adhar/ Udyog Memorandum in respective category.
22. Code of Integrity has to be maintained by Bidders/Suppliers/Contractors by maintaining highest standards of ethics in the Procurement process and prohibits corrupt practice/Fraudulent practice/Anti-Competitive practice / Coercive Practice/ Conflict of Interest and Obstructive practice either directly or indirectly during the process of contract.
23. Tender conditions (printed on the reverse), if any, or otherwise sent along with the tender shall not be binding on us.
24. A copy of **self- certification** about the products offered in this tender meets local content requirement for **Class- I Local supplier (local content equal to or more than 50% )** or **Class- II Local supplier (local content more than 20% but less than 50% )** as per **Make in India Policy No. P-45021/2/2017-PP(BE-II)dt- 16/09/2020, should be attached with bid.** The details of the **location(s)** at which the local value addition is made should also be mentioned in the self-certification.

**Exemption will be given as per the policy of Govt of India. Beyond the exemption limit, Non-local supplier will not participate in any tender, their bid will be rejected .Whenever Govt will issue any amendment in this policy, the same will be applicable accordingly.**

25. A copy of certificate regarding **Restrictions on procurement from a bidder of a country which shares a Land Border with India** wherein if any bidder from a country which shares a land border with India will be eligible to bid in any procurement whether of goods, services or work only if the bidder registered with the competent authority, should be attached with bid.
26. Above instructions & our standard terms & conditions must be complied failing which your offer may be liable for rejection.
27. Director, CSIR-CSIO, Chandigarh reserves the right to reject all or even the lowest quotation without assigning any reason. All disputes shall be settled in the courts of Chandigarh Jurisdiction only

Yours faithfully,

For & on behalf of CSIR-CSIO

---

**Bid-Security Declaration Form (BSD)**

(Refer para 5.1.2 (ix)(d) &amp; 6.1.1 (02) of the CSIR Manual-5F)

Date: \_\_\_\_\_

Bid No. \_\_\_\_\_

To:

(insert complete name and address of the purchaser)

\_\_\_\_\_

I/We. The undersigned, declare that:

I/We understand that, according to your conditions, bids must be supported by a Bid Securing Declaration.

I/We accept that I/We may be disqualified from bidding for any contract with you for a period of one year from the date of notification if I am /We are in a breach of any obligation under the bid conditions, because I/We

(a) have withdrawn/modified/amended, impairs or derogates from the tender, my/our Bid during the period of bid validity specified in the form of Bid; or

(b) having been notified of the acceptance of our Bid by the purchaser during the period of bid validity (i) fail or reuse to execute the contract, if required, or (ii) fail or refuse to furnish the Performance Security, in accordance with the Instructions to Bidders.

I/We understand this Bid Securing Declaration shall cease to be valid if I am/we are not the successful Bidder, upon the earlier of (i) the receipt of your notification of the name of the successful Bidder; or (ii) thirty days after the expiration of the validity of my/our Bid.

Signed: (insert signature of person whose name and capacity are shown) in the capacity of (insert legal capacity of person signing the Bid Securing Declaration).

Name: (insert complete name of person signing the Bid Securing Declaration)

Duly authorized to sign the bid for an on behalf of : (insert complete name of Bidder)

Dated on \_\_\_\_\_ day of \_\_\_\_\_ (insert date of signing)

Corporate Seal (where appropriate)

(Note: In case of a Joint Venture, the Bid Securing Declaration must be in the name of all partners to the Joint Venture that submits the bid)

MANUFACTURERS' AUTHORIZATION FORM (MAF)

(The Bidder shall require the Manufacturer to fill in this Form in accordance with the instructions indicated. This letter of authorization should be on the letter head of the Manufacturer and should be signed by a person with the proper authority to sign documents that are binding on the Manufacturer.)

Date: (insert date (as day, month and year) of Bid submission)

LPC NIT No: (insert number from Invitation for Bids)

To (insert complete name and address of Purchaser) WHEREAS

We (insert complete name of Manufacturer), who are official manufacturers of (Insert category of goods manufactured), having factories at (insert full address of Manufacturer's factories), do hereby authorize (insert complete name of Bidder) to submit a bid the purpose of which is to provide the Goods, manufactured by us (insert the category of Goods), and to subsequently negotiate to sign the Contract.

We hereby confirm that we shall be solely and fully responsible in case of discrepancy with regard to quality, quantity, Packages or defects at the time of supply/usage. In such cases we shall provide free replacement immediately.

Signed (insert signature(s) of authorized representative(s) of the Manufacturer)

Name: (insert complete name(s) of authorized representative(s) of the Manufacturer)

Title (insert Title)

Duly authorized to sign this Authorization on behalf of: (insert complete name of Bidder)

Dated on.....day of ....., ..... [Insert date of signing]

**TENDER ACCEPTANCE LETTER**

(To be given on Company Letter Head)

Date:

To,

\_\_\_\_\_  
\_\_\_\_\_Sub: Acceptance of Terms & Conditions of Tender.

LPC NIT No. \_\_\_\_\_

Dear Sir,

1. I/We have obtained/downloaded the tender document(s) for Tender/work namely:

\_\_\_\_\_  
as per your LPC NIT.

2. I/We hereby certify that I/we have read the entire terms & conditions of the tender documents from page no \_\_\_ to \_\_\_ (including all documents like annexure(s), schedule(s) etc) which form part of the contract agreement and I/we shall abide hereby by the terms/conditions/clauses contained therein.
3. The corrigendum(s) issued from time to time by your organisation/ department too has also been taken into consideration, while submitting the acceptance letter.
4. I/ We hereby unconditionally accept the tender conditions of above mentioned tender document(s) / corrigendum(s) in its totality / entirety.
5. I/ We do hereby declare that our Firm has not been blacklisted / debarred by any Govt. Department/ Public sector undertaking.
6. I/ We certify that all information furnished by the our Firm is true & correct and in the event that the information is found to be incorrect/ untrue or found violated, then your organisation/ Department shall without giving any notice or reason therefore or summarily reject the bid or terminate the contract, without prejudice to any other rights or remedy including the forfeiture of the full said earnest money/ security deposit/ PBG deposit absolutely.

Yours faithfully,

Signature of bidder

Name of bidder-

Official Seal of bidder-

**Format for declaration by the Bidder for Code of Integrity & conflict of interest**

(On the Letter Head of the Bidder)

Date \_\_\_\_\_

Ref.No: \_\_\_\_\_

To,

Sir,

With reference to your Tender No. \_\_\_\_\_ dated \_\_\_\_\_ I/We hereby declare that we shall abide by the Code of Integrity for Public Procurement and have no conflict of interest.

The details of previous transgressions of the code of integrity, if any, with any entity in any country during the last three years or of being debarred by any other Procuring Entity are as under:  
a b c

We undertake that we shall be liable for any punitive action in case of transgression/ contravention of this code.

Thanking you,

Yours sincerely,

CSIR-CSIO LPC NIT No \_\_\_\_\_

(Signature & Name of the Authorized Signatory with Company Seal)

\_\_\_\_\_  
(Name & address of the Purchaser)

**PRICE REASONABILITY CERTIFICATE**

(Should be printed in Company Letter head and signed by the authorized signatory with seal.)

This is to certify that the prices quoted for (Name of the Item offered) are best and minimum and we have not quoted the same on lesser rates than those being offered to CSIR-CSIO to any customer nor we will do till the validity of offer or execution of Purchase Order.

CSIR-CSIO LPC NIT No \_\_\_\_\_

*Signature*  
*(Name of the Authorized Signatory)*  
*Company Seal*

Self Certification by the Bidder for Local Content

(Refer to Order No. P-45021/2/2017-PP (BE-II) dated 16 September 2020)

**(On the Letter Head of the Bidder)**

Ref.No: \_\_\_\_\_

Date \_\_\_\_\_

**To:**

\_\_\_\_\_

*(Name & address of the Purchaser)*

S.No.	Name of Item	Percentage of Local Content	Location at which value Addition is made	Status of the bidder, whether, Local Supplier I /Local Supplier II or Non-Local Supplier.

As per OM No. . P-45021/2/2017-PP (BE-II) dated 16 September 2020 issued by Public Procurement Section, Department of Promotion of Industry and Internal Trade, Government of India-Class-I , Class-II Supplier and Non –Local supplier is as:

A) I / We certify that I / we come under **Class-I Local Supplier** Category whose goods / services local content is minimum 50%

**OR**

B) I / We certify that I / we come under **Class-II Local Supplier** Category whose goods / services local content is minimum 20%

**OR**

C) I / We certify that I / we come under **Non- Local Supplier** Category whose goods / services local content is less than 20%

**(Please Tick from A or B or C which is appropriate)**

We state that the value addition of local content is \_\_\_\_\_% and value addition has been made by us at \_\_\_\_\_ (mention the address please).

I / We hereby certify that the above statement is true and correct to the best of my knowledge. I understand that a false statement / declaration will disqualify / debar me from the process.

CSIR-CSIO LPC NIT No. \_\_\_\_\_

*Signature*  
*(Name of the Authorized Signatory)*  
*Company Seal*

(Refer to D.O.F. No.6/18/2019-PPD Dated, 28 July, 2020)

(TO BE FURNISHED ON BIDDER'S LETTER HEAD)

Date: \_\_\_\_\_

To

\_\_\_\_\_  
\_\_\_\_\_

**Sub: Certificate for Restriction on procurement from a bidder of a country which shares a Land Border with India**

LPC NIT No. \_\_\_\_\_

Name of Bidder: \_\_\_\_\_

Dear Sir,

*“I have read the clause regarding restrictions on procurement from a bidder of a country which shares a land border with India; I certify that this bidder is not from a country or, if from such a country, has been registered with the Competent Authority, I hereby certify that this bidder fulfills all requirement in this regard and is eligible to be considered. (Where applicable, evidence of valid registration by the Competent Authority shall be attached.)”*

Yours faithfully,

*(Signature & Name of the Authorized Signatory with Company Seal)*

(TO BE FURNISHED ON BIDDER'S LETTER HEAD)

**इलेक्ट्रॉनिक फंड ट्रांसफर खाता विवरण**

1	खाताधारक का नाम/ Name of account holder	
2	पता / Address	
3	ई-मेल आई डी / E-mail ID	
4	दूरभाष सं / मोबाईल नं / Phone No./Mobile No.	
5	फैक्स संख्या / Fax No.	
6	स्थायी खाता नंबर / Permanent Account Number (PAN)	
7	<b>बैंक खाता का विवरण/ Particular of Bank Account</b>	
	(क) बैंक का नाम / A. Name of the Bank	
	(ख) शाखा का नाम / B. Name of the Branch	
	(ग) शाखा कोड नंबर / C. Branch Code	
	(घ) पता / D. Address	
	(च) दूरभाष संख्या / E. Telephone No.	
	(छ) खाता संख्या / F. Account No.	
	(ज) खाता का प्रकार / G. Type of Account	
	(झ) आई एफ एस सी कोड (आर टी जी एस / एन ई एफ टी) / H. IFSC Code (RTGS / NEFT)	
	(ट) एम आई सी आर / I. MICR Code	

हम / मैं यह घोषित करते / करता हूँ की ऊपर दिए गए विवरण पूर्ण एवम् सत्य हैं अगर अपूर्ण एवम् असत्य जानकारी के कारण कारोबारी में देरी / विफलता होती है तो इसके लिए सी एस आई आर -सी एस आई ओ किसी प्रकार से जिम्मेदार नहीं होगा I We/ I hereby declare that the particulars given above are correct and complete. If the transaction is delayed or lost because of incomplete or incorrect information, I/ we would not hold CSIO responsible.

खातेदार का हस्ताक्षर/Signature of the account holder

दिनांक :

स्थान :

मुहर/seal

**PRICE SCHEDULE**

Name of the Bidder-

LPC NIT No.-

1	2	3	4	5	6	7	8	9	10	11	12
S. No	Item Description with HSN code	Country of Origin	Unit	Quantity	Unit Rate Ex-works, Ex-warehouse, Ex-showroom off the shelf price (inclusive of all taxes already paid)	Total price Ex-works, Ex-warehouse, Ex-showroom off the shelf price (inclusive of all taxes already paid) 5*6	GST & other taxes payable, if contract is awarded	Packing & forwarding up to station if dispatch, if any	Charges for inland transportation, insurance upto Lab /Instt. By air/road/rail (retain one only)	Total price	Installation, Commissioning and training charges, if any

Note: The cost of optional items, if any shall be indicated separately.

(b) Cost of spares, if any

Total Bid price in Indian currency (in numbers) \_\_\_\_\_  
(In words) \_\_\_\_\_

Signature of Bidder \_\_\_\_\_

Name of Bidder \_\_\_\_\_

Business Address \_\_\_\_\_

Dated: May 25, 2026

**TENDER: FABRICATION MIL GRADE NYLON, , FITMENT OF HOUSING, ONSITE TESTING, INSTALLATION AS PER DWGS**

REFERENCE: CSIO/IMW/FB/25-05-26/01

SUBJECT: FABRICATION, ASSY, VALID TEST REPORTS,

QUOTE VALIDITY: 90 DAYS, NO ADVANCE/EXTRA PAYMENT WILL BE GIVEN.

PAYMENTS WILL BE CLEARED AFTER SUCCESSFUL TESTING/INSTALLATION AS PER REQUIREMENTS

TECHNICAL DETAILS: ATTACHED, VARIATION IN MATERIAL/FABRICATION (10-15%)

CUSTOMIZED FABRICATION AS PER LOCAL/ONSITE REQUIREMENTS

VALID CERTIFICATION, AIRWORTHINESS REQUIREMENTS, TEST REPORT, STAGE INSPECTION, OPTIMIZATION/FEEDBACK ONSITE AS PER REQUIREMENTS

FABRICATION ON 5/6 AXIS AS PER PRECISION/ACCURACY & AS9100D COMPATIBLE

TERMS & CONDITIONS AS PER CSIO RULES.

CONTACT DETAILS (FOR ANY QUERY): [HARRY.GARG.CSIO@CSIR.RES.IN](mailto:HARRY.GARG.CSIO@CSIR.RES.IN)

  
Dr. Harry Garg  
Principal Scientist

डॉ. हेरी गर्ग / Dr. HARRY GARG  
प्रधान वैज्ञानिक / Principal Scientist  
संयुक्त वैज्ञानिक - केंद्रीय वैज्ञानिक उपकरण संगठन  
CSIR-Central Scientific Instruments Organisation  
असतो नमो भगवते वासुदेवाय

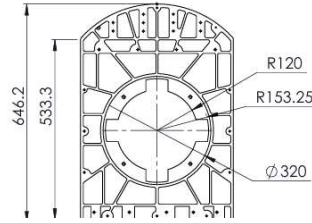
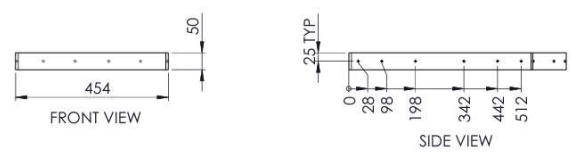
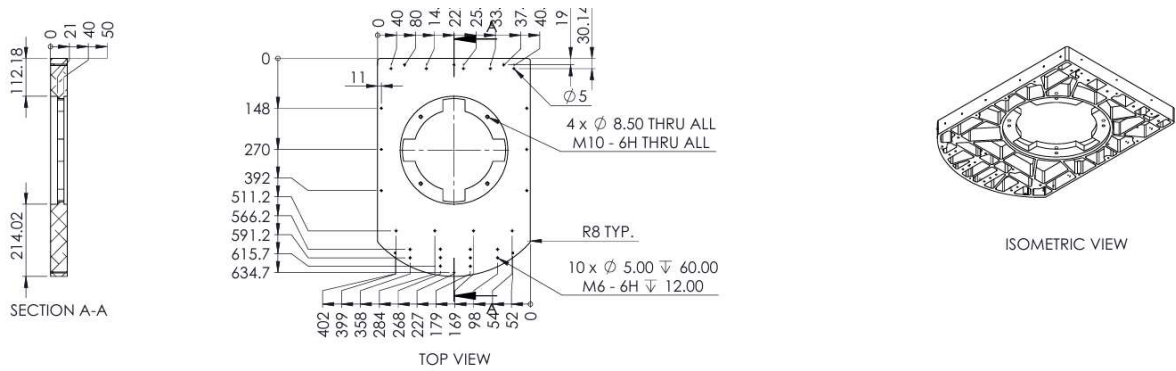

WEIGHT : 12706 ± 10% GMS

REMOVE SHARP EDGES & BURRS		TOL MET AFTER SURFACE TREATMENT		
PT NO 07	NO OFF 01	OPTICAL DEVICES	DRN	MS

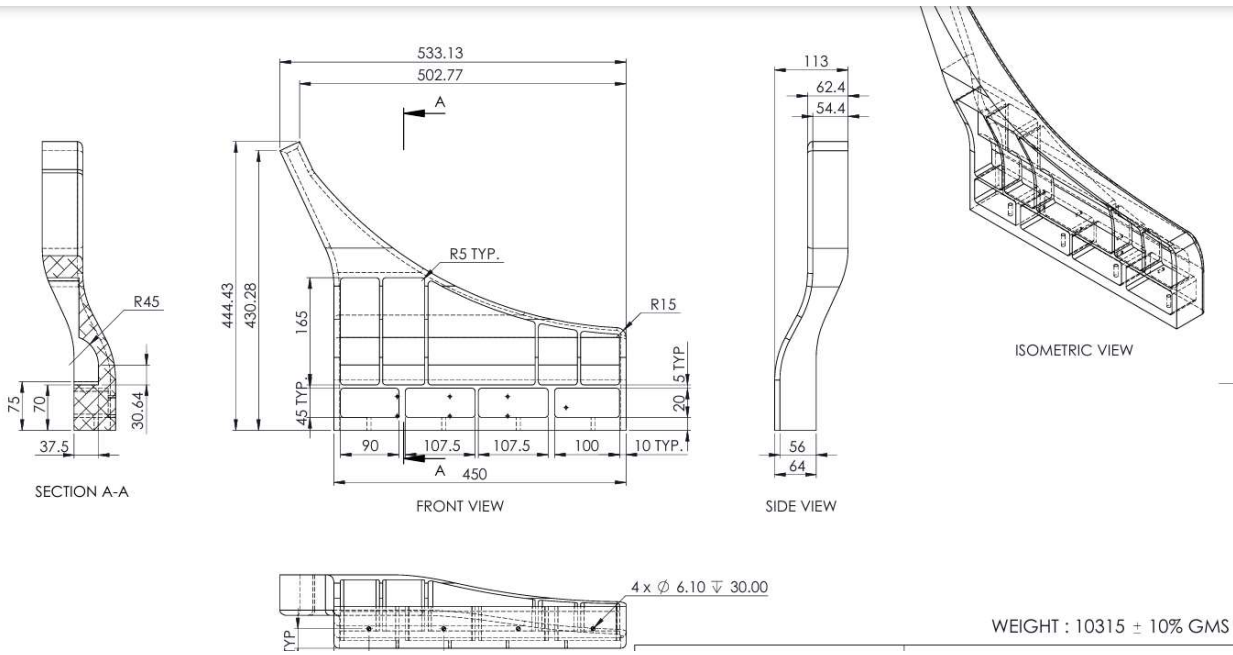

WEIGHT : 10315 ± 10% GMS

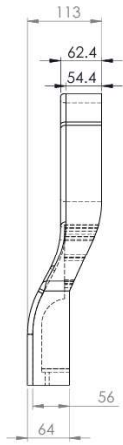

LEFT VIEW

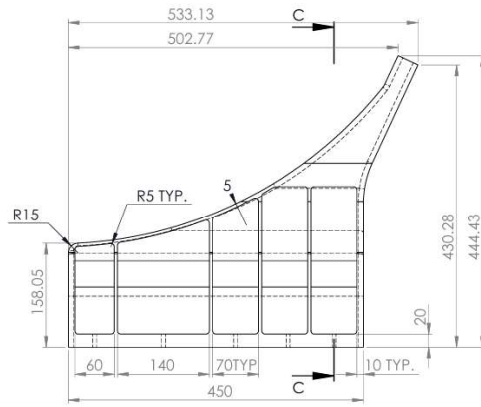

FRONT VIEW

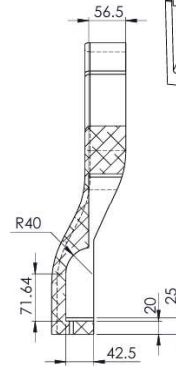

SECTION C-C

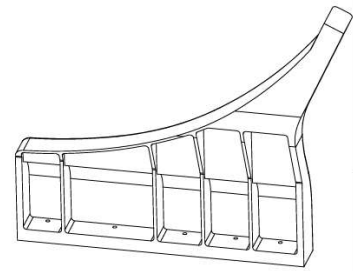

ISOMETRIC VIEW

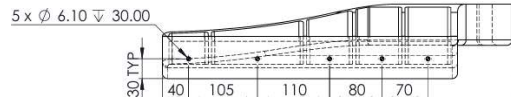

WEIGHT : 10293 ± 10% GMS

REMOVE SHARP EDGES & BURRS

TOL MET AFTER SURFACE TREATMENT