



CSIR-CSIO

TIME

2022

TECHNOLOGIST INDUSTRIALIST MEET & EXPO



सीएसआईआर - केंद्रीय वैज्ञानिक उपकरण संगठन

CSIR-Central Scientific Instruments Organisation

विज्ञान एवं प्रौद्योगिकी मंत्रालय, भारत सरकार

Ministry of Science & Technology, Govt. of India

CSIR-CSIO, Sector-30 C, Chandigarh-160030

TIME

2022

TECHNOLOGIST INDUSTRIALIST MEET & EXPO-2022

Showcasing of CSIR – CSIO Technologies



Organized by

CSIR-CENTRAL SCIENTIFIC INSTRUMENTS ORGANISATION

CSIR-CSIO, Sector-30 C,

Chandigarh-160030

In association with

TECKXPert KNOWLEDGE FOUNDATION

Bengaluru



Global Network of Technical Professionals

Date: 2nd December – 3rd December 2022



CSIR – Central Scientific Instruments Organisation





Prof. S Anantha Ramakrishna
Director, CSIR-CSIO



Message

It gives me immense pleasure to present the souvenir as a part of the TIME-2022 event organized by CSIR-CSIO, Chandigarh. CSIR-CSIO, Chandigarh was established in the year 1959 and has shown extensive growth in the Research and Development of Science and Technology over the years. CSIO Chandigarh has been instrumental in providing solutions in the multi-disciplinary realm, for industries and developed many systems & solutions for different sectors.

The laboratory has dedicated groups in the field of Imaging, Avionics, and Display Systems, Manufacturing Science and Instrumentation, Materials Science & Sensor Applications, Biomedical Applications, Intelligent Machines, and Communication Systems, Energy Management Technologies, Centre of Excellence for Intelligent Sensors and Systems, and Micro & Nano-optics Centre.

I'm very happy to note that CSIO, Chandigarh is organizing TIME 2022 for the first time showcasing some of the developed technological solutions in the domain of Biomedical, Environmental, Energy, and Strategic sectors. TIME 2022, hosted by the CSIO Chennai Centre, was a great event associating scientists with relevant industries with a prospect to commercialize the developed technologies.

I wish TIME 2022 event, organized at the CSIO Chandigarh, will be a great success by facilitating scientists' interactions with users and industries to plan and aspire for many such accomplishments of growth during the coming years.

Prof. S Anantha Ramakrishna



Dr. Sunita Mishra
Sr. Principal Scientist,
CSIR-CSIO



Message

I am extremely happy to organize the Technologist-Industrialist Meet and Expo TIME 2022 at CSIR-CSIO Chandigarh. It gives me immense pleasure to bring out the Souvenir on the occasion of TIME 2022. The CSIO was established in 1959 with a vision to support the needs of industries and institutions in up-keeping the Scientific and Industrial Instruments.

CSIO Chandigarh fosters R & D in multi-disciplinary areas with excellent infrastructure. The research areas can be broadly categorized as Agrionics, Material science & sensor applications, Avionics instrumentation & imaging, Biomedical instrumentation, Intelligent machines & Communication systems, and micro & Nano-optics.

Through TIME 2022, CSIO Chandigarh is showcasing its developed technological solutions in the domain of Biomedical, Environmental, Energy, and Strategic sectors. I hope TIME 2022 will bridge the gap by facilitating interactions among various communities under one umbrella for future directions.

Dr. Sunita Mishra



A Murugesan
Founding Chairman,
TeckXpert Knowledge Foundation



Message

It gives me immense pleasure to be part of Technologist Industrialist Meet & Expo-2022 (TIME - 2022). Its a great honour given to TeckXpert Knowledge Foundation as a co-organizer in this event. TeckXpert Knowledge Foundation founded in the year 2013, with the vision to bring together Research community, Industry experts, Business community and Educational Institutions for the sole purpose of Networking and knowledge sharing.

We at TeckXpert, strongly believe that our country has the potential become a Knowledge Hub for the world. Inline with this endeavor, TeckXpert would like to support all the initiatives taken by CSIR - CSIO in coming days too.

I am sure that the Industries and Business communities will utilize this great opportunity to know about many very useful technologies developed by CSIR - CSIO researchers and come forward for the technology transfer through this TIME-2022 platform which is the collaborative initiative of CSIR- CSIO and TeckXpert.

TIME -2022 would also serve as a platform for a brainstorming session with Industry thought leaders, Business leaders and Researchers to find out possible solutions for long pending pain points in various fields of Engineering.

These kinds of collaborative initiatives has the power to propel India to lead in all the future technology fields.

Come let's all join hands and do all the possible efforts to make our country a global leader in all the engineering fields.

A. Murugesan

CSIR-CSIO, Chandigarh

Central Scientific Instruments Organization (CSIO) established in 1959, a constituent unit of the Council of Scientific & Industrial Research (CSIR), is a premier national laboratory dedicated to research, design and development of scientific and industrial instruments. It is a multi-disciplinary and multi-dimensional apex industrial research & development organization in the country to stimulate growth of the Instrument Industry in India covering a wide range and applications.

The R & D facilities are being continuously upgraded and modernized to keep up with international standards in major areas of instrumentation covering electronics, electro-optical, IT, mechanical and optical providing technology based total solutions in Agriculture, Health, Strategic and Societal sectors including Energy Management.

CSIO is equipped with national level Analytical Instrument Facility (AIF), the Mechanical Design and fabrication facility (MDF), and the Electronic Design and Fabrication facility (EDF) & Thin film Coating facility fostering services to the Regional Industries, Educational institutes & Government Organizations

As a part of Academy of Scientific and Innovative Research (AcSIR), CSIO is accepting PhD scholars for both science and engineering. CSIO is also working in various areas of instrumentation and skill development programs by awarding diplomas through Indo-Swiss Training Centre (ISTC) at Chandigarh. CSIO is having its center at Chennai to meet the regional needs. Under Human Resource Development (HRD) activity, CSIO conducts technology-based entrepreneur development programs and training courses for instrument users on the operation, handling and preventive maintenance of instruments for national and international participants under Ministry of External Affairs (MEA) support.

|

Technologies Index

ENERGY MANAGEMENT	
Induction Motor Stethoscope (MSCOPE) for Industry 4.0	2
e-SENSE: A Non-Intrusive Load Monitoring Technique (NILM)	4
Smart Metering Technologies for Mass Housing (SMT-MH)	5
IoT enabled Air Quality Monitoring System (AQMS)	6
Universal Motor Performance Analyzer (UPMA)	8
Building Energy Management System (BEMS)	9
IoT Enabled Power Quality Analyzer (3 in 1 Smart Meter)	10
Portable & Universal Motor-Cum-Pump Performance Monitor (PU-MPPM)	12
Pump Efficiency Monitoring System (PEMS)	14
Power Quality Analyzer (PQA)	15
BIO MEDICAL & HEALTH CARE	
Robotic Wireless Cart	17
Virtual Reality for Neuro-motor Rehabilitation	19
Temperature & Flow Control Ultrasonic Spray System(t-FOCUS) for Nano- Drugs Formulation	21
Indigenous Electronic Apex Locator	22
Portable Solar-Powered Vaccine Cooler (SPVC)	24
Vein-viz- Image guided vascular vein visualizer	25
Ges-Chair: Finger gesture based alternative drive controller for motorized wheelchair	26
Machine for performing Double Volume Exchange Transfusion	28
Near Infrared Light Source Cum Photothermal Device	30
Intravenous Infusion Monitoring Device	31
ENVIRONMENT & SAFETY	
HMI Gauge: A Portable Colorimeter for Heavy Metals and Residual Chlorine Detection in Water	33
An apparatus for fabricating microfluidic channels on a hydrophilic paper substrate	35
AI based system for evaluating the quality of wheat and barley seeds	37
Precision Iodine Value Analyzer	38
Programmable Invisible Marker Authentication Device	40
Fertilizer Recommender	42
IOT based UV-C Standalone Air disinfection system	43
TPC based edible oil system	44
STRATEGIC	
Head Up Display (HUD)	46
Optical Landing System	47
LSO Operated Standby Optical Landing System	48
Bore Sighting System	49
Digital Holographic camera	50
Optical Gun Sight for Dornier DO-228 Aircraft	51

INFRASTRUCTURE & FACILITIES

Analytical Instrument Facility (AIF)	53
Mechanical Design and Fab Facility (MDF)	55
Electronic Design & Fab Facilities (EDF)	56
Thin Film Coating Facility (TFCF)	57
NABL Accredited Calibration Facility	58
INDO-SWISS Training Centre (ISTC), Chandigarh	59
Advertisements	60

ENERGY MANAGEMNT

Induction Motor Stethoscope (MSCOPE) for Industry 4.0

(Sponsored by Department of Science and Technology)

MSCOPE - Main Unit



MSCOPE - Signal Conditioner Unit



Introduction

MSCOPE is an instrument used to diagnose the health of Induction Motors. This technology is development is an ongoing project in CSIR-CSIO, Chennai and funded by IDP-DST, New Delhi. This Instrument employs Hybrid techniques like Motor Current Signature Analysis (MCSA), Vibration Analysis (VA) and Temperature Analysis (TA) to detect the Motors faults On-site, On-line and In-situ. The MSCOPE detects the faults and their severity level without removing the motor from the existing setup. The system uses hybrid algorithm for both diagnosis and detection of faults.

Features

- ✦ Capable of detecting 16 different faults present in an induction motor
- ✦ Highlights the faults detected and also displays the severity of the faults detected
- ✦ **Hybrid Measurement** (Vibration, Voltage, Current, Temperature)
- ✦ **Hybrid Analysis** (Vibration Analysis, Motor Current Signature Analysis, Temperature Analysis)
- ✦ **Hybrid Decision Making** algorithm for severity & location of fault (Fuzzy Logic, Machine learning and Artificial Neural Network)
- ✦ Three levels of diagnosis namely **Basic, Intermediate, Advanced** Diagnosis

Merits

- ✦ Early Fault Detection & Improved Accuracy
- ✦ Indication Of Precise Location & Severity of Faults
- ✦ Reduced Cost of Maintenance
- ✦ Reduced Process Downtime
- ✦ Efficient Use Of Energy

Applications

- ✦ Used to detect the faults in an induction motor at an early-stage
- ✦ Hybrid system improves the accuracy of fault detection
- ✦ Helps in predictive maintenance
- ✦ Also used for the Life Cycle Assessment (LCA) of motors being used
- ✦ Helps in energy-efficient usage of the motor

e-SENSE: A Non-Intrusive Load Monitoring Technique (NILM)

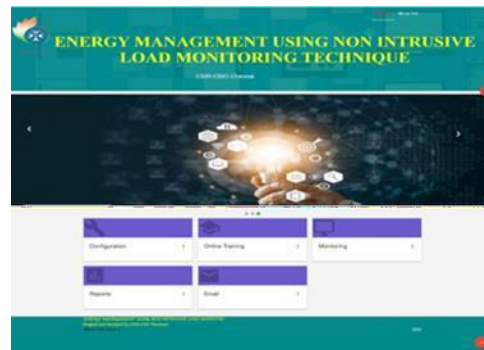

Introduction

'e-SENSE" (Energy Sense) device which is used to monitor the on/off status and energy consumption of individual appliances (loads) using Non-intrusive Load monitoring (NILM) technique. The developed e-SENSE is plug and play type device which can be connected to entry point of residential/commercial buildings. The e-SENSE uses AI/ML approach to disaggregate the individual appliance's status and energy consumption from the aggregated energy. The product can also be used for the anomaly detection of loads.

Features

- ✚ Measure and display the events/status and energy of the appliances connected to the powerline using single device
- ✚ Online load monitoring through web-enabled user interface and user-friendly dashboard
- ✚ Single unit capable of monitoring of individual loads connected to single/three phase power supply
- ✚ e-SENSE has capability to measure single/three phase loads up to 200 Amps
- ✚ Intelligent and robust AI/ML algorithm for load disaggregation from the aggregated load data
- ✚ Inbuilt Window 10 processor, Ethernet and Wi-Fi for interface
- ✚ Users can add/remove loads to the NILM system through GUI

Applications

- ✚ Energy Management of loads
- ✚ Health Monitoring of loads in mission critical applications
- ✚ Could be used as anomaly detection device
- ✚ Could be used for the Life Cycle Assessment (LCA) of loads

Smart Metering Technologies for Mass Housing (SMT-MH)



Introduction

Smart Energy meters developed by CSIR-CSIO are digital electricity meters built around low cost AVR Microcontroller. It supports Post-paid & Prepaid electricity billing system which can facilitate improved cash flow management in energy utilities. These energy meters can be connected in wireless network to communicate all the measured parameters using Wi-Fi, GSM protocols. These meters are incorporated with Anti-Tampering features. It can avoid the problems associated with billing, electricity thefts & deployment of man power for taking meter readings.

Features

Low Income Group (LIG)

- ✚ Single Phase (5-30A)
- ✚ Class 1 Accuracy,
- ✚ TFT Display
- ✚ Wi-Fi & GSM Enabled
- ✚ Networking through OS Server suitable for Mass Housing

Middle Income Group (MIG)

- ✚ Three Phase (5-40A)
- ✚ Class 1 Accuracy
- ✚ TFT Display
- ✚ Wi-Fi & GSM Enabled
- ✚ Networking through OS Server suitable for Mass Housing

High Income Group (HIG)

- ✚ Three Phase (5-60A)
- ✚ Smart Water, Electricity & Gas (WEG) Metering
- ✚ Class 1 Accuracy
- ✚ TFT Display
- ✚ Wi-Fi, GSM & Bluetooth Enabled (with Appliance Control)
- ✚ Networking through OS Server suitable for Mass Housing

Merits

- ✚ Less human involvement
- ✚ Cost flow management
- ✚ Minimizes tampering and thefts
- ✚ Saves overall time

Applications

- ✚ Residential House
- ✚ Special Functions
- ✚ Any domestic applications



IoT Enabled Air Quality Monitoring System (AQMS)

Air Quality Monitoring Node - Outdoor

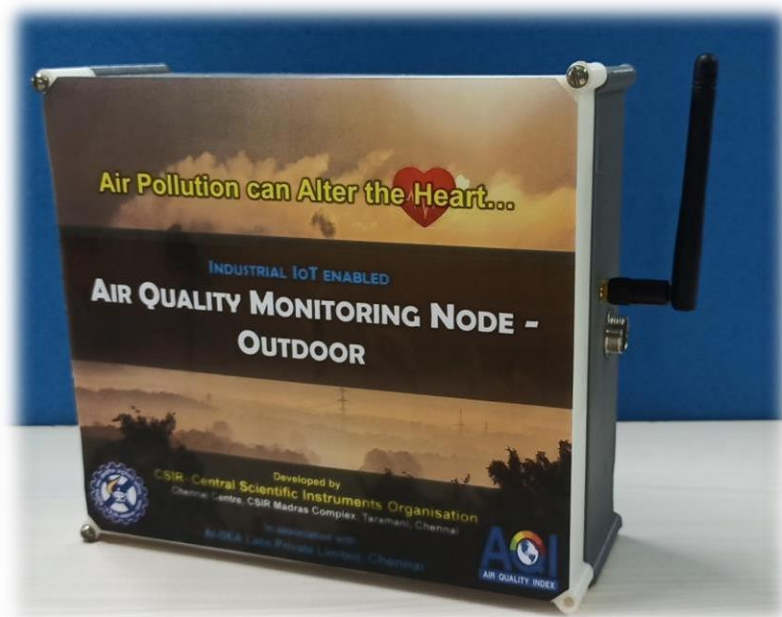

Air Quality Monitoring Node - Indoor



Introduction

CSIR-CSIO has developed a system for monitoring the indoor and outdoor air quality that follows Central Pollution Control Board. Ambient air monitoring is the monitoring of the quality of the air in a particular area. The local ambient air quality can be degraded by a number of sources such as diesel vehicles and power station emissions. The usual substances monitored include dust deposition, PM10, PM2.5, NO_x and SO_x. Ambient monitoring is often necessary as a condition of an IED license, permit, planning condition, to support license applications or as part of an EIS. A typical example of this is dust monitoring at a quarry to ensure dust levels are below those specified in the planning conditions.

Features

Air quality parameters detected as below

Particulate Matter

- PM 2.5
- PM 10

Ambience Parameter

- Temperature
- Humidity
- Pressure
- Altitude

Gases

- Carbon monoxide (CO)
- equivalent Carbon dioxide (eCO₂)
- Total Volatile Organic Compound (tVOC)
- Ozone (O₃)
- Stannic oxide (SnO₂)
- Nitrogen oxide (NO₂)
- Ethanol (C₂H₅OH)
- Hydrogen (H₂)
- Ammonia (NH₃)
- Methane (CH₄)
- Propane (C₃H₈)
- Iso butane (C₄H₁₀)
- Sulphur dioxide (SO₂)

Applications

- ✚ Industrial Perimeter Monitoring
- ✚ Roadside Pollution Monitoring
- ✚ Indoor Air Quality Management
- ✚ Planning Condition for Industrial Equipment

Motor Current Signature Monitoring (MCSA)

- Broken Rotor Bar Faults
- Eccentricity Faults
- Bearing Faults
- Short Turn Fault
- Load Torque Fluctuations

- Unbalanced Voltage



Universal Motor Performance Analyser (UMPA)

(Sponsored by Department of Science and Technology)



Introduction

The UMPA, developed by CSIR-CSIO displays the operating efficiency of motor by monitoring the electrical power input (like voltage, current & power) and shaft speed of the motor. The IMEMS determine the operating efficiency of motors without removing the motors from the field and without the need for measuring the output power or torque. The system uses few sets of data coupled with the special algorithm for evaluating the motor parameters instead of using the no-load and blocked rotor test results.

Features

- ✚ The UMPA can be used to operate the motor at its Best Operating Point (BOP) limits
- ✚ The system could be suitable for conducting on-site energy audits of existing motors which provides scientific data to replace or refurbish the existing motor
- ✚ UMPA can be used to check the performance of the motor after rewinding
- ✚ The system could also be used for Life Cycle Assessment (LCA) of motors being used
- ✚ This helps in replacing the existing energy-inefficient motor with new motor
- ✚ Motor performance can be analyzed without disconnecting the motor from the load (On site, On line and In situ)

Product Differentials

- ✚ Increases equipment efficiency
- ✚ Maintenance routine optimization
- ✚ Economy with spare parts replacement
- ✚ Add value to the product (OEM's)
- ✚ Add value to the service (maintenance companies)
- ✚ Downtime reduction

Building Energy Management System (BEMS)



Introduction

BEMS to monitor and control the entire building in terms of security, HVAC (Heating, Ventilation and Air Conditioning) status and energy consumption for effective energy management. Many physical parameters constrained to the building such as temperature, humidity, occupancy & door/window status, etc. are monitored and necessary control operations are implemented. In terms of security viz. vibration, smoke, fire, biometric acts as basic firewall for high end access. It provides a real-time data at the comfort of the office or any location desired. Analysing and remote access of collected data from the sensors allows end user to get alerts if certain thresholds are exceeded.

Features

- ✚ Measure and display the total energy consumption of the building.
- ✚ Monitor the events/status of the occupancy, doors, and windows of the rooms in building.
- ✚ Detect smoke and send timely alerts for necessary actions.
- ✚ Control the appliances such as air conditioners, lights and fans in the building.
- ✚ Monitors the room temperature to take necessary actions on controlling the air conditioners for maintaining the human comfort level in the building.
- ✚ Online monitoring through web-enabled user interface and user-friendly dashboard.
- ✚ Scheduled report generation and timely alerts to the user.
- ✚ Users can add/remove loads to the BEMS system through GUI.

Applications

- ✚ Energy Management in commercial/industrial buildings such as Hospitals, Hostels, Campus, Hotel Industries etc.

IoT Enabled Power Quality Analyser (3 in 1 Smart Meter)

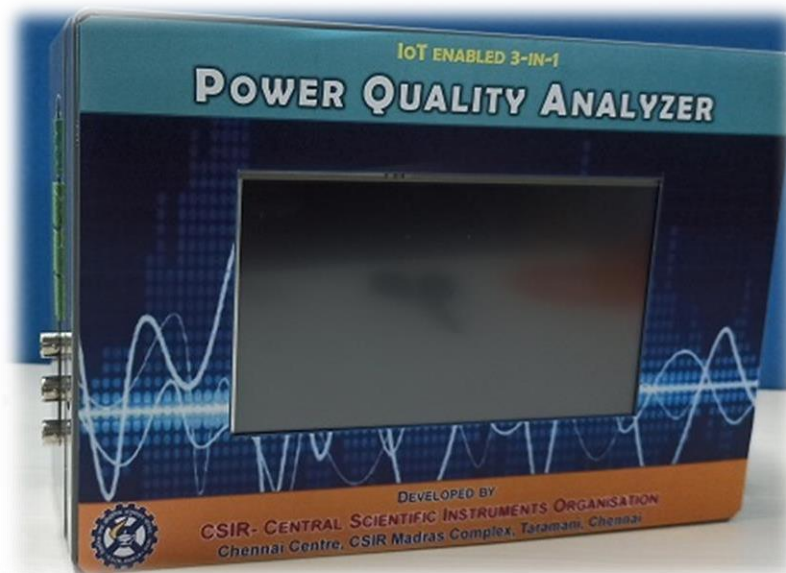

Introduction

A perfect power supply would be one that is always available, always within voltage and frequency tolerances, and has a pure noise free sinusoidal wave shape. Naturally, long power interruptions are a problem for all users, but many operations are very sensitive to even very short interruptions, harmonics, transients and unbalance. Voltage sags and power interruptions lasting a few hundredths of a second can be costly. Analysis of power being received is hence very important particularly in industries. Poor quality of power may result in breakdowns and consequent production loss. The industry needs to know its power supply quality by means of a tool, which takes the inputs and quantifies the power quality parameters at an affordable cost. IoT Enabled Power Quality Analyser will help to take corrective steps for improving the power quality of the supply, which in turn will reduce the down time and increase the productivity.

Features

- ✚ The PQA senses the electrical parameters such as 3 phase current, voltage and power factor from which Active Power, Reactive Power and Apparent Power are being calculated using the energy IC.
- ✚ This is also capable to detect basic power quality parameters like Sag, Over Voltage and Over Current
- ✚ PQA has a spectrum analyzer feature developed inside, i.e. the node is capable to capture time-domain signals for all the electrical signals and convert into frequency domain up to a bandwidth of 3.3 kHz
- ✚ PQA is also capable of detecting basic power quality parameters such as Sag detection in each



individual phase, Over Voltage & over current detection in all the phases individually.

- ✚ The node has a feature of detecting Phase sequence error and reverse active & reactive power.

Product Differentials

- ✚ Measurement in 1-phase and 3-phase systems (3 and 4-wire),
- ✚ Measurement of voltage, current, harmonics, power, energy, inrush current, flicker
- ✚ Graphical presentation of data in a waveform and vector diagram
- ✚ Record of Events: Dips, Swells, Overvoltage and Overcurrent
- ✚ Health status of transformer can be accessed through internet

Portable & Universal Motor-Cum-Pump Performance Monitor (PU-MPPM)

Developed PU-MPPM Prototype and tested in Indian Navy

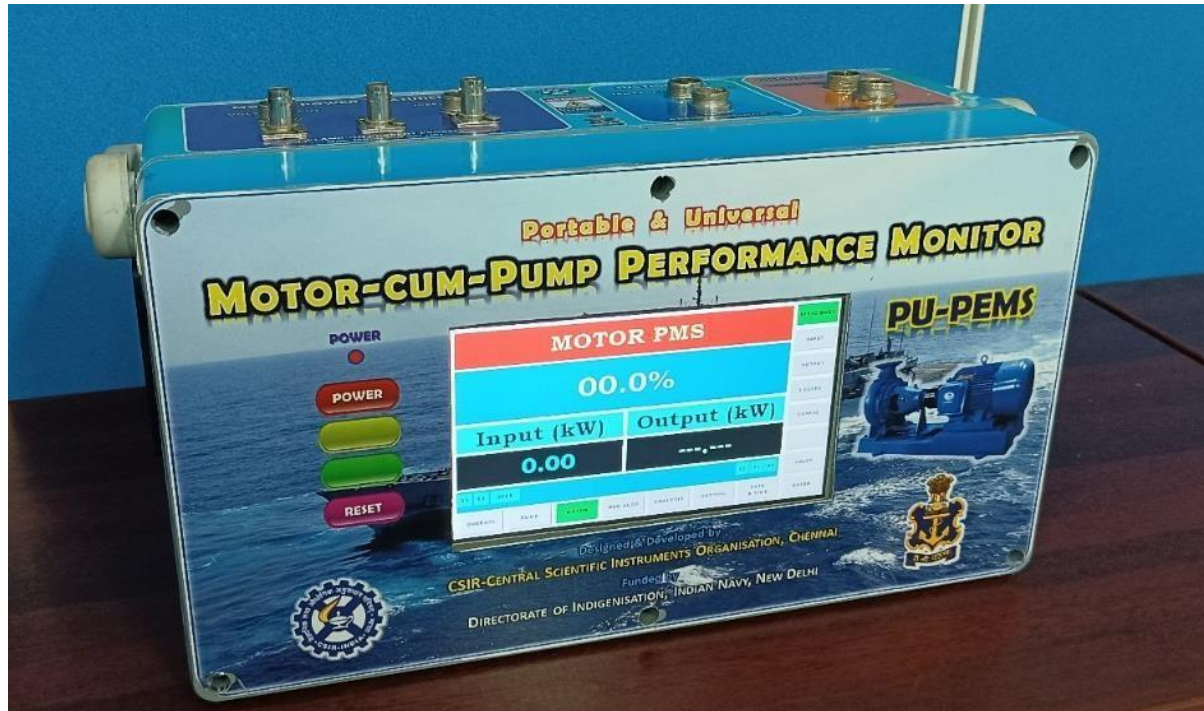

Introduction

PU-MPPM is an ultimate cost-effective tool for monitoring the efficiency of the pump, motor and overall on-line, on-site and in-situ. Presently the efficiency of the pump is monitored either off-line or by measuring the flow using commercial flow meters or using high cost ultrasonic flow meters and then the efficiency is back calculated. PU-MPPM involves an indirect method of calculating the flow by measuring the efficiency of the pump along with the electrical power input to the motor. The system integrates pump and motor performance monitoring into a single system providing a portable and universal solution for any range of motor and pump.

Features

- ✚ The methodology is based on estimating the wire-to-fluid efficiency, which is defined as the product of pump and motor efficiency.
- ✚ The overall performance monitoring of the system, comprising of both the pump and the motor driving the pump will be carried out by the hybrid technique of measurement.

- ✦ The temperature, pressure on both suction and discharge side along with the electrical power measurement and shaft speed are monitored and processed.
- ✦ The motor operating efficiency, torque & losses are calculated from the equivalent circuit using a proprietary algorithm called GA.
- ✦ The overall efficiency along with motor and pump efficiency will be displayed on a GLCD/TFT display, and the same information will be transmitted to the remote monitoring system using Ethernet.

Product Differentials

- ✦ Computing the efficiency of the Pump without measuring the flow
- ✦ Flow rate is indirectly derived from the efficiency
- ✦ Reduced cost of maintenance
- ✦ Detection of abnormality in Motor and Pump separately can be accomplished

Pump Efficiency Monitoring System (PEMS)

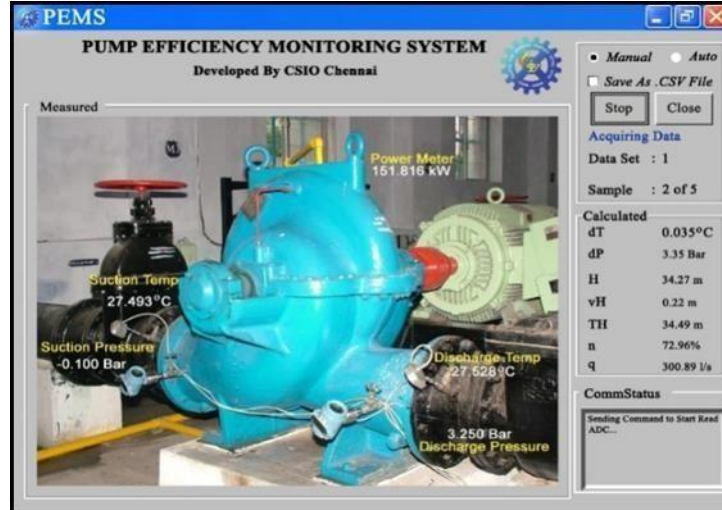

Introduction

For establishing baseline data associated with energy saving proposals, real time measurement of electrical and physical parameters is necessary. Since affordable logging equipment is not available, the energy saving proposals is usually based on the data provided. The Portable Energy Audit Tool has been developed keeping in view the requirements of energy auditors to log various parameters. The tool is ready for field-testing.

Features

- Single unit capable of on-line monitoring of suction temperature & pressure, discharge temperature & pressure, electrical power, head, efficiency & flow rate of the pump
- Temperature measurement with accuracy of 0.001 °C
- Power measurement with an accuracy of 1%
- Capable of configuring the pump parameters
- Capable of displaying & logging data in *.CSV (Comma Separated Values) format for analysis

Product Differentials

- On-line Flow & Efficiency measurement with an accuracy of 1%
- Operation of pump with optimum energy consumption
- Proper Planning & Maintenance of the pump
- Refurbishment of the pump at the appropriate time periodically to increase lifecycle

Power Quality Analyzer



Introduction

CSIR-CSIO's PQA is a compact state of art equipment designed for utilities, as well as for industrial & commercial customers. It can continuously monitor power quality in accordance with established standards, also the built in flexibility allows the user to set customized setting. PQA helps in monitoring and controlling harmonics injection limits specified by CEA which will save industries avoid penalties from the State DISCOMs. It is also useful for identifying the causes of equipment failures in critical sectors such as health, IT, ceramic, glass, power and petrochemical industries.

Features

- ✚ The Power Quality Analyser measures the power quality events like impulse transient, swell, sag, harmonics, phase sequence, unbalance along with basic electrical parameters like voltage, current, power factor, power and energies in a three phase four wire system
- ✚ This PQA can be connected at the incoming line and can also be used as a stand-alone instrument with facility for displaying the PQ parameters
- ✚ The PQA can be connected to a PC to download the data for permanent data storage and analysis via RS 232. This can also be connected to a network using MODBUS-RTU protocol

Applications

- ✚ Measurement in 1-phase and 3-phase systems (3 and 4-wire),
- ✚ Measurement of voltage, current, harmonics, power, energy, inrush current, flicker
- ✚ Graphical presentation of data in a waveform and vector diagram
- ✚ Record of Events: Dips, Swells, Overvoltage's



BIO MEDICAL & HEALTH CARE

Robotic Wireless Cart

Robotic Hospital Logistic Cart model with modular configurations



Introduction

The Robotic Hospital Logistic Cart is a remotely controlled robotic cart which works on an easy-to-use sliding finger gesture interface based on Android mobile device with Bluetooth connection support for wireless maneuvering. Android App is the cost-effective alternative of expensive wireless joystick controllers. Its modular configuration provides option of easy customization to multiple applications.

Features

- ✚ Touch contact using finger over the drive screen activates the motion control, and maintaining finger contact enables full driving capabilities by sliding similar to physical joystick, including turning, veering, and spinning around
- ✚ It is based on Android Application and the intuitive virtual joystick-based drive screen with speed control
- ✚ The system is equipped with electronic brakes and capable to drive motorized wheels simultaneously in differential mode to achieve uniform movement in any direction.
- ✚ Multiple attachments and modular design provides multiple options of its usage in hospital, office, indoor and outdoor environments where social distancing is required with option of controlling the cart from a distance of 100 feet and also monitoring the activities through cart mounted camera

Merits

- ✚ Can be used to go in hazardous environments, sanitization, and fume spray
- ✚ Useful to supply food, water and medicine to any contingency ward
- ✚ Automates the manual processes in various environments Applications

Applications

- ✚ It is useful to safeguard front-line healthcare workers dealing with infectious patients during food items distribution as well as for packages handling from a distance.

Virtual Reality for Neuro-motor Rehabilitation

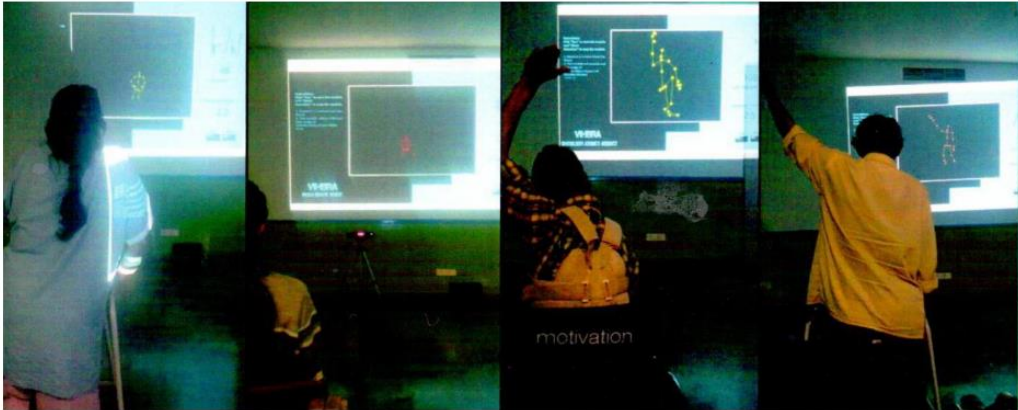

Introduction

This is a virtual intelligent platform for motor rehabilitation of persons with disabilities. It combines experience from virtual reality and knowledge from machine intelligence to enhance neural reorganization that optimizes the physical rehabilitation outcomes in individuals with disability. It provides stimulating sensory feedback to promote motor learning and encompasses tools that help to understand the biology of disability. The system integrates inexpensive devices like Microsoft Kinect and Wii Balance Board to improve balance and neuromuscular functions. Quantification of motor disability is done through presenting the individuals with situations/tasks that require use of groups of muscles and body parts like an augmented rehabilitation measure such as virtual function reach test.

Benefits

- ✦ Real-time visual feedback of the executed movements allows the persons with disabilities to perceive a picture of patient's movement projected on the screen in real-time and correct compensatory postural adjustment and movement learning
- ✦ Visual response combined with verbal instructions by the system (zero physiotherapist assistance), can ease the learning of body postures with better biomechanical arrangement while executing the tasks and activities.
- ✦ Therapy system provides intense, continuous and repetitive training to the individuals with disability, simultaneously bringing maximum engagement through fun, animated virtual environments.
- ✦ The system incorporates a novel virtual functional reach test, modified functional reach test and other clinical measures that makes daily quantification of improvement lot easier.

Applications

- ✦ The virtual rehabilitation system developed has been used on patients with spinal cord injury in an ethically approved clinical trial.
- ✦ The rehabilitation system includes therapy exercises for standing balance, sitting balance, range of motion, and strengthening exercises for both upper and lower limbs
- ✦ The developed system engages patient in a multidimensional, multisensory virtual environment.
- ✦ Motivation and voluntary engagement of patients to perform rehabilitation through the developed system.

Temperature & Flow Control Ultrasonic Spray System) for Nano- Drugs Formulation



Introduction

The enrichment in bioavailability and optimal use of the therapeutic substances (API/drug) is one of the most important concerning aspects of the pharmaceutical industries. This Temperature and Flow Control Ultrasonic Spray (tFOCUS) is System make poorly water-soluble therapeutic substances to soluble by formulation of these substances into nano form, form without any chemical modification the active constituents of substances or use of prohibitive substance. The tFOCUS System compactable to make nano-formulation of temperature sensitive therapeutic active ingredients in rapid and large scale quantity. This system has flexibility to vary the process parameters by select the pre-program mode and easy to handle and portable system.

Applications

- ✦ Nano-formulation of active substances for Pharma, Nutraceuticals, Food & Cosmetic Industries
- ✦ Herbal Extraction for Pharma Industries
- ✦ Thin/thick film coating for Textile & Packaging Industries
- ✦ Fabrication of Micro/Nano-Composites for Biomedical and Energy Storage applications

Indigenous Electronic Apex Locator



Introduction

Working length is the distance between the coronal/incisal reference point and the area that has been prepared and at which the filled canal should end. Failure to determine the root canal length can result in both over- and underestimation of the root canal length. Overestimated working length can result in preparation beyond the apical isthmus, which can damage the periapical region. Underestimated working length and inadequate debridement can cause unsuccessful treatment and dissatisfaction of both the patient and dentist. Finding the accurate working length of a tooth is very crucial when it comes to Root Canal Treatment. Working length determines how much filling is actually required for the treatment. It is possible to measure the working length using impedance-based spectroscopy during the treatment in real time. Electronics Apex locator is an impedance based device which will measure the working length of the root canal during the treatment. According to Indian dental market survey report by Morulaa Health Tech, India is having more than 500 dental laboratories & 297 dental institutes. With this available dental infrastructure, Indian dental market is vast, and it will be the single largest country for dental products and materials.

Features

- ✚ Multi frequency technology to measure the impedance of the root canals.
- ✚ Locate the apical foramen with great precision under a wide range of canal conditions
- ✚ Automated calibration of the device.
- ✚ User friendly interface, endo files can be tracked visually on a screen with audio signals and digital indicators.
- ✚ Powered by a rechargeable battery, eliminates the need for frequent battery replacement.

Benefits

- ✚ Electronic Apex Locators reduce the number of radiographs required and assist where radiographic methods create difficulties.
- ✚ Measurement of pulpitis, pulp necrosis, periapical periodontitis and tooth length.
- ✚ Measurement of the tooth length before restoration of post crown.
- ✚ Detects the root canal perforation.
- ✚ Recognize any connection between the root canal & periodontal membrane such as root fracture and cracks.
- ✚ Confirm suspected periodontal or pulpal perforations during pinhole Preparation.

Applications

- ✚ For use in Dental department of hospitals



Portable Solar Powered Vaccine Cooler (SPVC)



Introduction

SPVC is a cost-effective and fast response solar powered Vaccine cooler to maintain the temperature of the vaccine during its transportation and distribution using thermo-electric Peltier modules and using the state of the art instrumentation.

Features

- ✚ Faster response because of Peltier Module based design
- ✚ Fuzzy based Effective Temperature Controller with an accuracy of $\pm 0.1^{\circ}\text{C}$
- ✚ Three Source of Power – Solar + LiPO Battery + AC Mains powered
- ✚ TFT display with user friendly GUI

Applications

- ✚ Vaccine Distribution in the rural areas
- ✚ Vaccine Transportation with minor modifications in the storage
- ✚ Traveler Medicine Bag etc.

VeinViz: Image-Guided Vascular Vein Visualizer

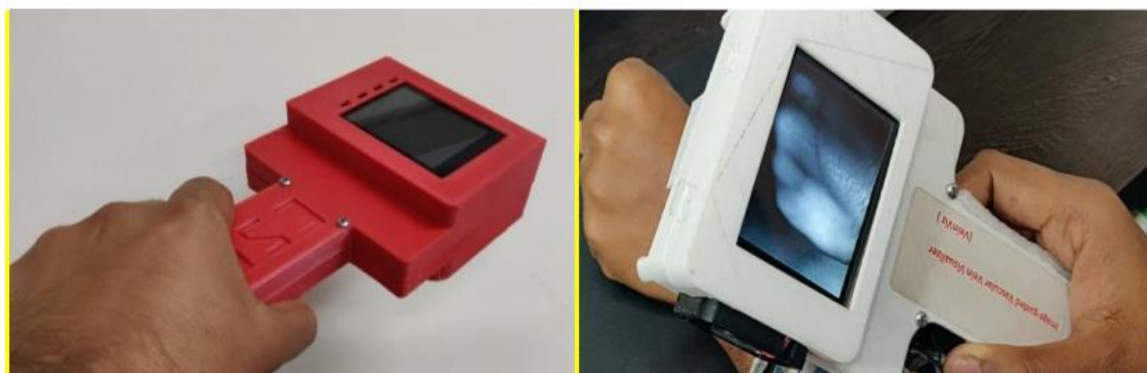

Introduction

Analysis Vein-Viz is an indigenous and handheld vein visualizer device to view venous information in real-time on a screen. The vein detection approach is based upon infrared imaging. It is very useful for persons with hidden or difficult to access veins.

Features

- ✚ Imaging based vascular detection and localization for precise catheter insertion or piercing of peripheral veins
- ✚ Indigenous, affordable and portable device for vascular vein detection and visualization
- ✚ Visualization capability for difficult to access hidden veins in children, obese and elderly
- ✚ Option to detect veins towards different body characteristics and skin tones
- ✚ Non-invasive & non-contact design towards patient safety from infections

Benefits

- ✚ Portable and Handheld instrument

Applications

- ✚ Clinicians, Hospital ICUs & In-patient Wards, Clinical & Diagnostic Centres, and Blood Banks for locating veins for intra-venous treatment of patients.
- ✚ Indigenous, affordable and portable device for vascular vein detection and visualization

Ges-Chair: Finger gesture based alternative drive controller for motorized wheelchair



Introduction

It is an industry ready alternate drive solution based upon finger gestures on the capacitive touch screen for maneuvering the motorized wheelchair. It consists of an affordable and indigenous motion drive incorporated with rear collision detection. Due to the absence of care-givers, currently available mobility solutions needs to be upgraded using alternative drive controls to help make independent mobility possible. The imported version of general purpose motion controllers comes with stiff Joysticks only and are very costly due to which the wheelchair manufacturing in India is expensive at the moment.

Features

- ✦ Easy to use sliding finger gesture based touch screen control module with graphics capability have speed control, lock screen & drive screen.
- ✦ Finger gesture on touch screen module based alternative drive controller works similar to joystick controller, compatible with any motorized wheelchair chassis available.
- ✦ Touch screen proportional controller requires no force to activate and drive.
- ✦ Touch contact using finger with the screen activates the device.
- ✦ Maintaining finger contact enables full driving capabilities by sliding similar to physical joystick, including turning, veering, and spinning around.
- ✦ Alternate drive controller is affordable, universal input capable with option for rear obstacle alert.

Applications

- ✦ Sliding the finger on capacitive touch screen device for elderly/paraplegics with weak upper limbs can make independent mobility possible when a standard joystick isn't the best opt

Machine for performing Double Volume Exchange Transfusion - DVET



Introduction

Severe jaundice (hyperbilirubinemia) is a common problem amongst newborn infants. Most infants with severe jaundice require only phototherapy but a few do not respond to it and end up requiring a double volume exchange transfusion. Double volume exchange transfusion involves replacing the entire blood volume of the neonate twice over with adult donor blood. In India and other developing nations, a disproportionately high number of jaundiced neonates require double volume exchange transfusions.

Features

- ✚ Automates the manual procedure of exchange transfusion through umbilical vein.
- ✚ Ensured and well calibrated smooth flow of the blood into the baby and out of the baby at all times.



- ✦ Reduces the chances of unintended hypervolemia, hypovolaemia, haemodynamic fluctuations.
- ✦ Based on double syringe pump technology.
- ✦ Biocompatible and disposable fluid flow circuit.
- ✦ Air-bubble and clot detection.
- ✦ Device can be started again from the same position where it was paused during error.

Benefits

- ✦ Reduces wastage of time, frustration and fatigue amongst doctor.
- ✦ Eliminates the manual process of double volume exchange transfusion in neonates, which is laborious, tedious, repetitive and prone to error.
- ✦ Maintains a fixed flow rate of infusion and extraction and reduces chances of mechanical haemolysis.
- ✦ Reduces chances of human errors occurring during the present manual process like missing phases of a cycle or entire cycle, incorrect volume of blood withdrawn/infused, accidental infusion of air bubbles or clots.

Applications

- ✦ For use in Neonatology department of hospitals.

Near-infrared Light Source cum Photothermal Device



Introduction

The device utilizes a halogen lamp, optical assembly comprising of lenses & spectral filter element to get Near-infrared optical output of desired centre wavelength and spectral bandwidth through replaceable optical bandpass filters. There is provision of integrated thermocouples for measuring the temperature of a medium/sample on irradiation (light interaction) and temperature control through synchronized operation of the light source.

Features

- ✦ Operational modes: Automatic/ Semi-automatic/ Manual lamp ON/OFF Temperature measurement with accuracy of 0.001°C
- ✦ Integrated four thermocouples for synchronized temperature data acquisition
- ✦ Arduino based control feedback to attain the set temperature
- ✦ Timer function / Temperature threshold function to stop the lamp/irradiation
- ✦ Temperature data acquisition in soft format on a PC through USB interface
- ✦ Replaceable optical band pass filters to tune the spectral output
- ✦ Special feature: High optical power handling & spectral extraction

Product Differentials

- ✦ Photochemistry, Photobiology, Life sciences, Plasmonics, Material Characterization
- ✦ Biomedical applications: Photothermal therapeutics, Biophotonics, Photomedicine
- ✦ Photothermal phenomenon to generate set temperature within a medium/sample
- ✦ Excitation source for Microscopy, Spectroscopy and Fluorescence etc.

Intravenous Infusion Monitoring Device



Introduction

Intravenous infusion monitoring device is meant to monitor and quantify the intravenous infusion, a frequently used modality in a hospital ward or during the disaster etc. Apart from active monitoring, this device also provides infusion quantification, alarms and auto-stop features. The device utilizes optical principles and micro-controller based computations to monitor, quantify and display the infusion parameters. Also, once the drug/saline bottle becomes empty, the intravenous catheter tube is automatically blocked to prevent the back flow of blood. This will reduce the need of frequent monitoring by the hospital/nursing staff. Such device is probably required for almost every bed in a hospital ward, so considerable market potential is envisaged.

Features

- ✚ Displayed infusion parameters: Flow rate (Drop rate), Drop count, Bottle volume, Time to empty
- ✚ User inputs: Bottle volume, Drops/ml
- ✚ Audio alarms: intermittent alarm if remaining drops
- ✚ Micro-controller based quantification and display of the infusion parameters
- ✚ User interface through push buttons and LCD display
- ✚ Infusion data acquisition in soft format (if required) through USB interface to a computer
- ✚ Special feature: Auto stop of infusion, alarm for delay/interruption during infusion, Dual sensor based reliable monitoring.

Product Differentials

- ✚ For intravenous administration of drug/saline etc
- ✚ Such device is required for almost each and every bed in a hospital

ENVIRONMENT & SAFETY

HMI Gauge: A Portable Colorimeter for Heavy Metals and Residual Chlorine Detection in Water

Portable Colorimeter for Heavy Metals and Chlorisense

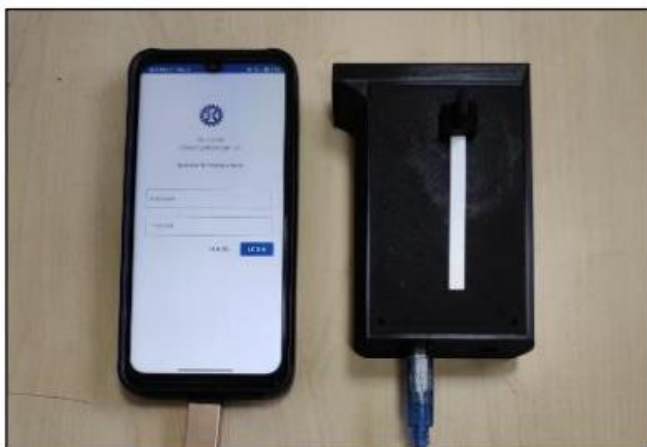

HMI Gauge – Mobile Application



Introduction

Water parameters analysis is currently done with colorimetric field test kits, including reagent kits and paper strips, and the results are analysed by comparing the color with a color comparison chart, which is a subjective method of quantification. Also, the result obtained is not recorded in real-time. To overcome this issue, we have developed a portable device that can be used in the field to quantify the color response of test strips. The developed device has currently two versions including hand held and USB shaped colorimeter, and it can be used with any existing commercial test strips for color based testing of water quality/pollutants. A mobile app, named, HMIsense is available for image capturing, analysis, and quantification of color response for heavy metals (proof of concept established for mainly lead detection in water) detection.

Features

- ✚ Portable Colorimeter to Read Paper Strips for Heavy Metals and Residual Chlorine
- ✚ Mobile App, HMISense to Quantify Heavy Metals and Residual Chlorine Level
- ✚ Qualitative and Quantitative Analysis of above parameters in Water
- ✚ Smart Phone Integrated Portable Device
- ✚ Low Water Sample Requirement
- ✚ Modular device extendable to other parameters and reagent kits
- ✚ Bluetooth/Wireless connectivity
- ✚ Data transfer to cloud/local server
- ✚ Information availability about testing site and time

Merits

- ✚ Indigenously developed and environment friendly reagent kits
- ✚ 3D printed, Light Weight, and Modular Design
- ✚ Extendable to colorimetric reagent kits
- ✚ Mobile App based Data Quantification
- ✚ Real time data acquisition and transfer

Applications

- ✚ For use in water analysis for heavy metals and residual chlorine quantification
- ✚ Extendable for multiple water parameters testing based on color change test strips
- ✚ Extended to any diagnostic application based on the color change

AN APPARATUS FOR FABRICATING MICROFLUIDIC CHANNELS ON A HYDROPHILIC PAPER SUBSTRATE

APPARATUS FOR FABRICATION OF MICROFLUIDIC CHANNELS

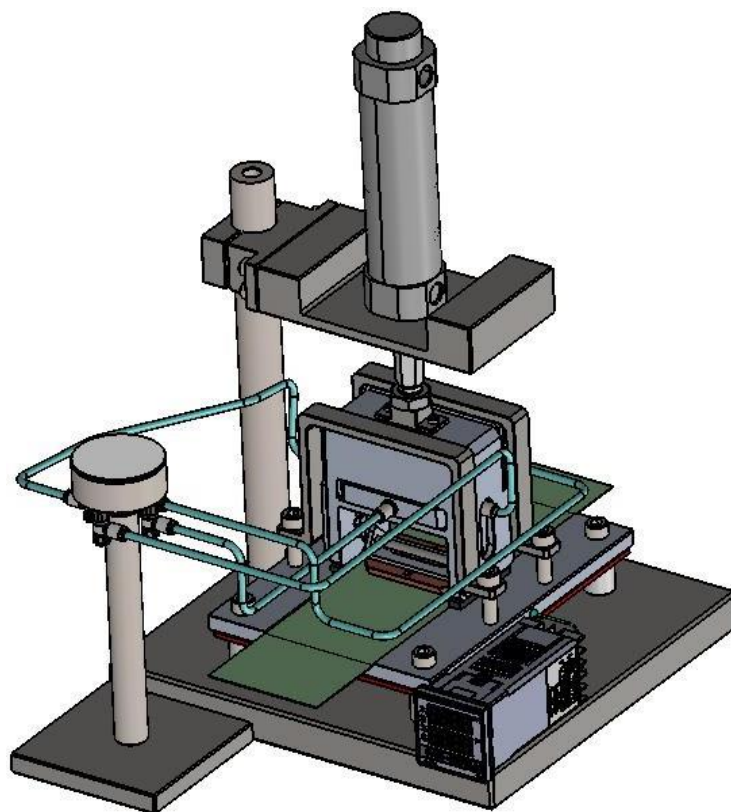

AN EXEMPLARY μ PAD

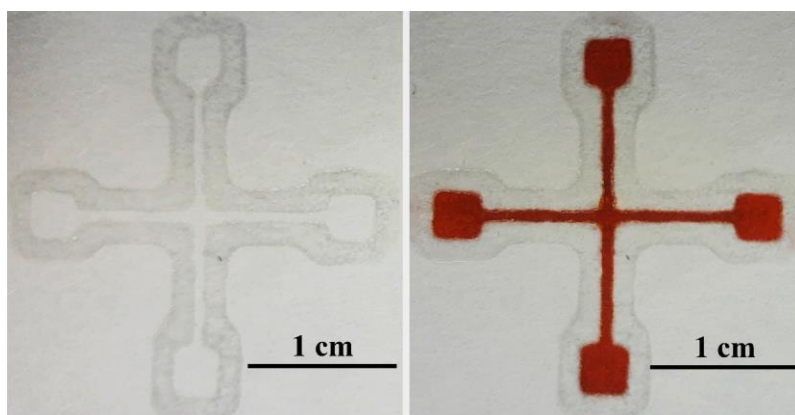

Introduction

The modular apparatus can generate user-defined microfluidic pattern on hydrophilic and porous substrate (filter or chromatographic papers). This apparatus acts as a fabrication assistant for conducting paper-based microfluidic assays for biomedical research, environmental monitoring, food quality control and related products. This microfluidic patterning method facilitates the production of multiple copies of paper based microfluidic analytical devices (μ PAD) (e.g. a filter paper sheet of 8 inch x 12 inch can be sliced into 30-32 μ PADs having a size of 34 mm x 34 mm with a completely filled hydrophobic ink reservoir).

Features

- ✚ Paper Substrates: Filter paper or chromatographic paper with appropriate pore size
- ✚ Microfluidic pattern: Mass production of customized geometric pattern with hydrophobic-hydrophilic contrast regions
- ✚ Minimum channel width of μ PAD: 900 to 1300 microns (based on lab experiments)
- ✚ Minimum sample volume: 20 micro liters
- ✚ IPR status: Provisional Indian patent (IN202111032728)

Merits

- ✚ Ease of operation
- ✚ Field compliance
- ✚ No additional pre- or post-process μ PAD treatments required
- ✚ Modular assembly
- ✚ Provision of changeable stamping tool, choice of hydrophobic ink and the type of paper substrate

Applications

Fabrication assistant for conducting a variety of paper-based microfluidic assays for biomedical research, environmental monitoring, food quality control and related products.

AI based system for evaluating the quality of wheat and barley seeds

Digital Grain Moisture Analyzer



Introduction

It is based on capacitance variation technique. The instrument comprises of mainly an analog section and a digital section. For controlling the complete functioning of DGMA, it uses power efficient, high speed microcontroller (MCU) chip. The sensing system is made up of capacitive transducer that converts moisture contents into an electrical signal. Presence of a very small quantity of water causes considerable change in the dielectric constant of the sensor cell. These moisture variations change capacitance and in turn are measured in terms of frequency variations. These variations are then further trend fitted and calibrated in terms of percentage moisture. The final result in terms of moisture percentage, temperature of sample, date and time of measurement is displayed on LCD for a given sample under measurement.

Benefits

Very small quantity of moisture can also be measured

Applications

For grain harvesting, procurement, storages and food processing industries, etc to ensure right quality and perseverance of quality

Precision Iodine Value Analyzer

Precision Iodine Value Analyser



Introduction

Iodine value is the measure of degree of unsaturation of esters present in oils. It is expressed as a gram of iodine per 100 gram of the oil/fat. This value is considered as imperative quality indicator of oils & fats (viz. melting point, hardness, gumming, and drying power, hydrogenations). Conventionally, Iodine Value is determined using manual titration and few analytical instruments based on automated titration are also available in the market. Apart from longer time of analysis, these techniques/instruments use toxic chemicals like glacial acetic acid, iodine monochloride, mercuric acetate and chloroform. Also, special laboratory setup is required for handling these chemicals. Our team at CSIR-CSIO specializing in Analytical Chemistry, Computational Chemistry, Machine Learning and Hardware Development; have developed this unique technology for Iodine value measurement which reduces analysis time, minimizes toxicity and is economical. Our technology uses a specially optimized reagent and machine learning algorithms to predict a fair and accurate Iodine Values of Oils & Fats. The technology can be customized for all types of Oils & Fats. The technology is available for commercialization on non-exclusive basis

Merits

- ✚ Titration free
- ✚ Rapid analysis
- ✚ Precise and accurate
- ✚ Minimal safety requirement
- ✚ Low cost of analysis
- ✚ Low maintenance & operation cost
- ✚ Easy sample preparation
- ✚ Easy operation
- ✚ Highly customizable

Applications

- ✚ Oil extraction units
- ✚ Quality control and assurance labs
- ✚ Food regulatory authorities
- ✚ Soaps and cosmetics
- ✚ Bakeries
- ✚ Meat industry
- ✚ Paint industry
- ✚ Charcoal
- ✚ Biodiesel
- ✚ Ghee and Butter

Programmable Invisible Marker Authentication Device

Programmable Invisible Marker Authentication Device (PiMAD)



Introduction

Programmable Invisible Marker Authentication Device (PiMAD) has been developed for reading and authenticating UV sensitive markers printed using UV sensitive inks produced by M/s Aron Universal, Bangalore. These inks can be used to print security markers on various surfaces without compromising the aesthetics of the background surface. These markers can be any textual, pictorial or codes (bar and QR codes). With the popularity of such security markers the demand for such reading devices is imperative.

Merits

Low cost and customisable

Applications

Reading and authenticating security markers printed on various merchandise

Fertilizer Recommender



Introduction

Digital holography is an important technique for performing qualitative as well as quantitative non-destructive testing. Conventional digital holographic techniques suffer from vibrations of the system & environment and their small field of view is also a hindrance for wide range of applications. A novel opto-mechanical design has been developed which imparts the holographic system portability by reducing the effect of vibrations and simultaneously increases its field of view.

Features

- ✚ Portability is realized by integrating the laser source used to generate the hologram.
- ✚ CCD sensor used to record the hologram digitally,
- ✚ Optical components used to increase the field of view inside a compact mechanical housing equipped with vibration.
- ✚ Figure of merit of the developed digital holographic camera was measured in terms its temporal stability, enhanced field of view and low exposure time requirement.
- ✚

Applications

- ✚ Suitable for displacement measurement, defect detection and measurement, delamination detection, pressure detection, thermal stress measurement, real time NDT etc.

IOT based UV-C Stand alone Air disinfection system



Fig.: Induct UVC disinfection system installed inside railway coach.

Introduction

The UV-C Air Duct Disinfection System is designed as a retrofit table unit into existing HVAC Air Ducts using customizable UV-C dosage as per the existing CFM. It consists of a sliding mechanism, a regulated UV light source, and sensors. The device is used as a retrofit attachment to any existing Air Duct by minor modifications (Cut Slot and fitting) into it. The UV-C light intensity is carefully controlled to give the required dosage to the given airflow to inactivate any Virus & bacteria present. Presently, the intensities are calibrated to inactivate the COVID 19 virus in similar simulated flow conditions in the laboratory. The mechanism allows the user to position the light source in place easily and easy removal as and when maintenance or cleaning is required.







Features

- ✚ Induct UVC Air disinfection System for HVAC building duct.
- ✚ Induct UVC Air disinfection System for HVAC Train.
- ✚ Induct UVC Air disinfection System for HVAC Buses.
- ✚ PURElevator- Circulating Air disinfection System for Lift, Closet, office.

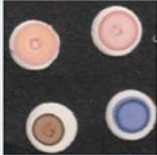
Applications

- ✚ Above systems were used for air disinfection/sanitization in buildings & lifts, Train & buses, offices etc.
- ✚ UVC AIR disinfection Systems are installed at CSIR- HEAD office (Delhi), CSIRCSIO Chandigarh.

TPC BASED EDIBLE OIL SYSTEM

Kries test I	Kries Test II	Peroxide value	p-anisidine value	Hexanal (ppm)	Sensor Response	
					Before Exposure	After Exposure
Negative	0.013	1.44	0.36	0.448		
Positive	1.003	12.88	5.46	5.031		
Positive	2.281	22.35	9.94	11.316		

Introduction

The rancid oil or food products made using rancid oil produce off-flavors and taste bad. We may not fall sick immediately after consuming rancid oil/food, but this can cause long term health effects. Chemical metabolites such as peroxides and aldehydes produced on rancidification can damage cells and contribute to serious health implications. This was the motivation to develop an easy and low cost sensor for the detection of rancidity in edible oils.

Features

- ✚ A visual detection method for the monitoring of rancidity in edible oils.
- ✚ The strips have been fabricated and tested in laboratory for more than 50 samples.

Applications

- ✚ The rancidity of edible oils.

STRATEGIC

HEAD UP DISPLAY



CSIO built Head UP Display Mk1 in LCA-AF Cockpit



Flight Symbology viewed through HUD Mk1 in LCA-AF

Introduction

Head-

Head Up Display (HUD) is an essential aid to the pilot of aircraft, especially fighter aircraft. It is a transparent display that presents data without requiring the pilot to look away from his usual viewpoint. The information is projected on to semi-reflective transparent glass through a combination of special projection technology, optical assembly and display source. HUD displays flight information such as altitude, airspeed, angle of attack, navigation, weapon aiming and other flight information in collimated form so that the pilot is able to view the information with his/her head "up" and looking forward, instead of looking down on other instruments mounted in the cockpit. It can also be used to adequately overlay imagery that has a physical relation to the real environment, which makes the information easier to apprehend, such as the runway symbology under poor weather conditions. A head-up display gives pilots access to the critical flight information needed to safely fly the aircraft while allowing them to focus their attention outside the cockpit for potential conflicts or threats. The combiner glass is provided unique coating with material or combination of materials so as to reflect green wavelength, to which human eyes are most sensitive, while allowing everything else seen through in the forward direction. The HUD Mk1 interface electrically with Open Architecture Computer of the aircraft and displays flight symbology as well as Forward Looking Infrared Camera (FLIR) captured IR video of the outside environment.

Status

- ✚ DGAQA and CEMILAC approved full qualification testing performed conforming to MIL standard 810D, 461C and 704D.
- ✚ Airworthy certification and successful flight trials. Under regular production by Bharat Electronics, Panchkula.

OPTICAL LANDING SYSTEM

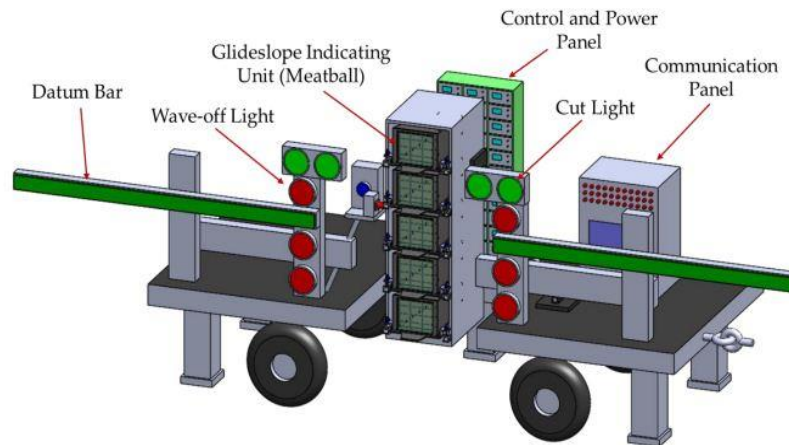

Introduction

Challenges during Landing on Aircraft Carrier:

- Runway space for landing is about 150 m
- Landing area is spanned by 3 to 4 arresting wires.
- Each plane has a tail-hook. Pilot's goal is to snag the tail-hook on one of arresting wires.
- OLS provides glidepath information to pilot during landing, to place aircraft tail hook at center of landing area. Meatball's virtual image is formed 150 ft. behind lens creating distinguished displacement cues for pilot.
- Vertical beam width (one light cell): 0.3°
- Vertical beam width (whole system): 1.5°
- Azimuth beam width (whole system): 20° Distance from deck to detect meatball: $1\text{NM}=1.852\text{km}$
- Higher resolution enables resolving meatball from datum light at 0.5 NM from deck.
- If aircraft gets dangerously low, ball appears red. If aircraft gets too high, ball appears to go off the top.
- Retrofit solution for upgradation of LUNA-3E OLS with improved detection range & increased resolution.
- Datum Bar: Provides the pilot a reference against which he may judge his position relative to the glideslope
- Wave Off Light: Switched ON in case the deck is not ready for landing or the aircraft is too low on glideslope that it may hit the deck (Manually controlled by LSO).
- Glideslope Indication Unit (Meatball): Indicates the relative position of the aircraft with reference to glide slope.
- Cut Light: Earlier in no-radio or "zip-lip" approach, it is flashed for approx. 2–3 seconds to indicate that aircraft is cleared to continue the approach. Subsequent flashes are used to prompt the pilot to add power.

LSO Operated Standby Optical Landing System



Introduction

Manually Operated Visual Landing Aid System (MOVLAS) is a backup shipboard visual landing aid system that is used when the primary Optical Landing System (OLS) is inoperable, when stabilization limits are exceeded, or for pilot/LSO training. The system presents glideslope information in the same visual form presented by the OLS system. The MOVLAS source light is operated by the LSO using a special controller.

Features

- ✚ An emergency system to be used when OLS is inoperable. Source light is operated by the LSO using a special controller.
- ✚ MOVLAS source lights comprise 23 lights (17 Amber & 6 Red) arranged in two closely spaced vertical rows.
- ✚ Three lights at adjacent heights are operated to form the source lights.
- ✚ As the controller handle is moved upward or downward, the source lights are switched on progressively towards the top or bottom in clusters of three.
- ✚ This gives an approaching pilot the signal to increase or decrease his elevation to achieve the proper glideslope as directed by the LSO.

Applications

- ✚ The MOVLAS is an emergency system to be used when OLS is inoperable.

Bore Sighting System



Introduction

Bore Sighting System (BSS) is an opto-mechatronic equipment with design certified by the Centre for Military Airworthiness & Certification – Regional Centre for Military Airworthiness (CEMILACRCMA) Chandigarh. The system is used to install and harmonize cockpit display and optronic systems at the desired position in the aircraft cockpit with reference to the aircraft axis (Fuselage Reference Line - FRL). It provides harmonization capability within tolerance of 1mR for harmonization distance of 60m. With this accurate harmonization, the target positioning for these Optronic Equipment would be within 9 feet for a distance of 20 kms.

Applications

- ✚ BSS provides harmonization on Ground before pre-flight and installation of Line Replacement Units (LRUs) such as Head Up Display & Multifunction Displays, Gun Sights, Bore Sighting Tool for Laser CSIR-Central Scientific Instruments Organisation Ranger & Marked Target Seeker (LRMTS), SPA Payloads, Bore Sight Harmonization Tool, Gun Sights, Optical Sights & Holographic Optical Sights in Aircraft, Tanks, Ships, Helicopters & Military Surface Vehicles.
- ✚ Harmonization of Optronic Equipment such as Head Up Display & Multifunction Displays, Gun Sights, Bore Sighting Tool for Laser Ranger & Marked Target Seeker (LRMTS), SPA Payloads, Bore Sight Harmonization Tool, Gun Sights, Optical Sights and Holographic Optical Sights.
- ✚ Harmonization through BSS is carried out at ground only while harmonization error correction is done on the actual field vehicle (aviation, navy and army vehicle) and field platform.

Digital Holographic camera



Introduction

Digital holography is an important technique for performing qualitative as well as quantitative non-destructive testing. Conventional digital holographic techniques suffer from vibrations of the system & environment and their small field of view is also a hindrance for wide range of applications. A novel opto-mechanical design has been developed which imparts the holographic system portability by reducing the effect of vibrations and simultaneously increases its field of view.

Features

- ✚ Portability is realized by integrating the laser source used to generate the hologram.
- ✚ CCD sensor used to record the hologram digitally,
- ✚ Optical components used to increase the field of view inside a compact mechanical housing equipped with vibration.
- ✚ Figure of merit of the developed digital holographic camera was measured in terms its temporal stability, enhanced field of view and low exposure time requirement.
- ✚

Applications

- ✚ Suitable for displacement measurement, defect detection and measurement, delamination detection, pressure detection, thermal stress measurement, real time NDT etc.

Airworthy Units of Optical Gun Sights used in Dornier DO-228 Aircraft



Introduction

The Optical Gun Sight, designed and developed by CSIRCSIO, is an optical instrument for aiding the pilot for sight setting on a particular range. The OGS has been designed to be used with both eyes open. While one eye looks into the sight through the collimator, the other one looks through the Gun Sight for landing of the aircraft. The eye looking into the sight sees an illuminated reticle together with the periphery of the scene through collimator. A view of the periphery of the scene is important as it enables binocular vision to be maintained so that the visual axis of each eye is coordinated by enabling the pilot for landing the aircraft.

Features

- ✚ Passive illumination.
- ✚ Compact opto-mechanical system
- ✚ Focus at infinity
- ✚ 2-Lens system
- ✚ Customized Graticule

Applications

- ✚ Primary Application: Optical Gun Sight
- ✚ Secondary Application: Daytime Landing System

INFRASTRUCTURE & FACILITIES

Analytical Instrument Facility

CSIO Instrumental methods of analyses form an indispensable aspect of any R & D program. Keeping in view the inability of small educational institution and industries to procure and maintain sophisticated analytical instruments, Analytical Instruments Facilities (AIF) has been set up.

AIF at CSIR-CSIO, Chandigarh houses a variety of sophisticated analytical instruments which are operated and maintained by a dedicated and qualified group of Scientists and Engineers. It is an integral part of CSIR-CSIO and operates with an "open access policy". The result of this policy is that all can benefit from the services of AIF.

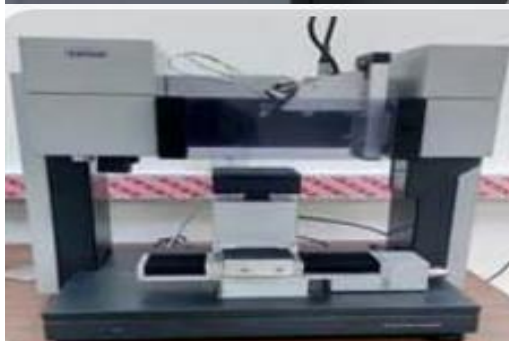

The main objectives of AIF facilities are:

- To provide open access to instrumentation facilities to scientists and other users from academic institutes, R&D laboratories and industries to enable them to carry out new break through research of tomorrow.
- To organize innovative training programs, outreach and meetings/workshops on the use and application of various analytical techniques for new user populations.
- To provide facilities of sophisticated analytical instruments to scientists and other users from academic institutes, R&D laboratories and industries to enable them to carry out measurements for R&D work.
- To support the researchers for the development of new measurement/analytical techniques /processes/instrumentation in diverse areas of science and technology.



Mechanical Design and Fab Facility (MDF)

Activities:

Mechanical Design and Fab Facility is engaged in mechanical design, fabrication & metrology related work for various R&D activities at CSIR-CSIO, Chandigarh. Major work involves mechanical, optical fabrication & assembly, measurements for mechanical and optical components and support to ISTC for teaching & lab work in the allied area.

Expertise:

The group comprises of technical manpower having expertise in design, fabrication, operation and measurements of following types, Multiphysics engineering simulations, Rapid prototyping through 3D printers, fabrication & assembly of optical as well as mechanical components, grinding & polishing of metals and optical materials (glass etc.), electric discharge machining, laser machining, CNC vertical machining center, mechanical and optical metrology, measurements of surface roughness & surface profiles, tensile and compressive strength measurements, 3D scanning of components, welding, ball milling, tool and cutter grinding, coordinate & contour measurements, wear and hardness testing etc.

Facilities:

Major facilities/machines available are:

- Rapid prototype machines (Plastic parts)
 - Metal 3D printer EOS M290
 - EDM/Wire cut EDM
 - Universal testing machines
 - CNC grinding and polishing machine
 - Optics metrology marform MFU 200
 - Ultra-precision single point diamond turning (Nanoform-200)
 - Glass slicing machines
 - Laser centering machines for optical assembly
 - Tri Optics auto-collimators
 - Mechanical profilometer
 - Optical profilometer
 - Optical trepanning machine
 - Laser cutting machine
 - Jig boring machine
 - Swing milling machine
 - Micro-precision lathe
 - Power shearing/ Hacksaw
 - Rolling and bending machine
- 3D scanner 5-250 mm

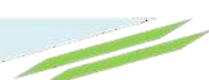

- Micro/Ball milling machine
- Wear testing machine
- Welding machines
- Conventional lathes, Grinding, polishing, milling, drilling machines
- Tool and cutter grinder
- CNC vertical machining center
- Coordinate measuring machine
- Contour measuring machine
- Drafting machines
- Hardness tester
- Surface roughness tester

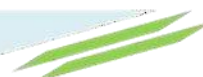

Electronic Design & Fab Facilities (EDF)

Activities:

Being a multi-disciplinary organization CSIR-CSIO, Chandigarh have well equipped laboratories manned by highly qualified and well-trained staff with various infrastructural facilities. As a national laboratory in the area of Instrumentation, a well-established Centralized Facility for Electronics Design and Fabrication (EDF) is available in the organization

Facilities:

The facility have following instrumentation related expertise:

- Analog and Digital Circuit Designing
- Analog and Digital Circuit Fabrication
- Analog and Digital Circuit Modification
- Embedded System Designing, Fabrication and Modification
- PCB Designing
- PCB Fabrication (2 layer without PTH)
- PCB Modification
- PCB Assembly (SMD Level)
- PCB Testing

Thin Film Coating Facility (TFCF)

Activities:

TFCF in CSIR-CSIO, Chandigarh is equipped with advanced facilities for design, fabrication and characterization of thin film coatings for different applications. The Laboratory has established facilities for depositing films of Metals, Metal and Semiconductor Oxides and alloys by thermal evaporation, RF sputtering and Ion assisted e-beam evaporation. The facilities allow the preparation of films under controlled conditions and the study of structural, thermal, electrical, and optical properties by using various spectrophotometric characterization techniques.

Expertise:

The group comprises of Scientists and Technical Staff having expertise in design of complex optical coatings and multilayer structures, fabrication of multilayers and optical characterization of thin films.

Facilities

Facilities Available Major coating facilities available in this group are:

- Ion Assisted Dual E-beam Gun Coating System (for oxides)
- Thermal Evaporation System
- RF Sputtering System

NABL Accredited Calibration Facility

CSIO Chennai has a well-established calibration laboratory serving more than 500 industries every year. The laboratory is equipped with highly accurate and sophisticated calibration standards (Secondary Standards) for electro technical, mechanical, temperature & optical instruments / parameters. The wide customer base covers the government sector institutions like IGCAR, ISRO, Tamil Nadu Electricity Board, Tamil Nadu Pollution Control Board, Railways, PSUs like ONGC, BPCL, BHEL, HPCL, IBP etc. and private companies from different sectors of industry viz., Cable, Pharmaceutical, Cement, Textile, Automotive, Adhesive, Chemical, Glass etc. The calibration laboratory has accredited by NABL for Electro technical and mechanical parameters. The Centre also conducts training programs on SOPs' for instrument calibration to technical persons involved in calibration labs.



Electro Technical

The Centre has the following equipment to calibrate the parameters such as AC/DC voltage, AC/DC current, resistance, capacitance, energy, frequency, power factor and time.



Mechanical

The Centre has the following equipment to calibrate the parameters such as pressure, linear dimensions, mass, force, speed, etc.,



Temperature, Optical & Analytical

The Centre has the following equipment to calibrate the parameters such as temperature sensor, transmitters, humidity, spectrophotometers, pH, Conductivity meters etc.



INDO-SWISS Training Centre (ISTC)

Indo-Swiss Training Centre (ISTC) was established in the year 1963 in collaboration with the Swiss Foundation for Technical Assistance, Switzerland. ISTC was formally inaugurated on 18 December 1963 by the first Prime Minister, Pandit Jawahar Lal Nehru. It is being run under the aegis of CSIR - Central Scientific Instruments Organization (CSIR-CSIO).

Need for Establishment of ISTC

Post independence, Industrial growth took place at high pace and at that time most of the machinery was imported. To operate and maintain that machinery there was a lack of skilled manpower. To cater to this need, ISTC was established. ISTC pioneered a unique style of skill based training program to impart state-of-art technical education to infuse professional endowment with technical competence and leadership qualities in the trainees.

Training Objectives

The basic objective of ISTC is to produce young technical personnel with solid practical background in the area of Design, Manufacturing, Instrumentation, Mechatronics and Industrial Automation. The focus of the training

- ✚ To impart quality education and build precision skills
- ✚ To infuse thorough knowledge by imparting industry oriented practical training and making the trainees professionally competent
- ✚ To instill self confidence in the trainees to make them successful in all walks of life including entrepreneurship

Unique Training Methodology

ISTC is a Training Centre of repute in the field of Technical Education and even today after 50 plus years of its inception, it has maintained an excellent quality of training. These courses are duly approved by All India Council for Technical Education (AICTE), New Delhi.

- ✚ Inculcating instinct to Work with Own Hands, imbibing Right Work Habits & building Precision and Quality as a natural instinct with 20% Theory and 80% Practical Training
- ✚ Hands-on practical exposure on the State-of-the-Art Equipment/ Machinery and also Exposure to Live Industrial Projects and Real-Life Work Environment
- ✚ Regular Industrial Visits, Guest Lectures from Industrial Experts, Rigorous Job counseling & Placement
- ✚ Overall Development with Emphasis on Punctuality, Cleanliness, Discipline, Housekeeping, Obedience, Pride in Labour, Teamwork etc.
- ✚ A Rigid System of Performance Evaluation by Continuous & Close Monitoring of Trainees at every step



CSIR - Central Electronics Engineering Research Institute
Pilani, Rajasthan, India



Serving the country since 1953 through

- Technology Development
- Sponsored/Contract R&D
- Consultancy
- Skill Development

IN THE AREAS OF

Electronic Instrumentation

- Advanced Information Technologies Group
- Integrated Circuits and Systems Group

Microwave/Vacuum Devices

- Vacuum Electron Devices Group
- High-Power Microwave Systems Group
- High-Frequency Devices and Systems Group

Semiconductor Devices & Smart Sensors

- Semiconductor Sensors and Micro-Systems Group
- Semiconductor Process Technology Group

Some of the Devices and Technologies Developed

- Accelerometer, Diamond Detectors, Sensor Interface Circuits, Gas Sensor Platform, Low Temperature Co-fired Ceramic Technology based Circuits, MEMS Hotplate, Silicon Carbide Schottky Diode Detectors, MEMS Ultrasonic Transducers, MEMS Acoustic Sensors, Selective Ion Sensors, Biosensors, ISFET based PH Sensor, Hybrid Microcircuits (HMCs) for SROSS and INSAT series of Satellites, Re-configurable System Design, Application Specific Instruction-set Processor Design, 16/32-bit Microprocessor Design, P-MOSFET Gamma-ray Dosimeter, Piezoresistive Pressure Sensor, Capacitive Pressure Sensor, InP-InGaAs based PIN Photo Detectors, 980nm Pump Laser Diode, C-band High-power GaAs MESFETS and Amplifiers
- 140 W Ku-band Space TWT, 2.6 MW Magnetron for LINAC, Mercury-free VUV/UV Plasma Source, Pseudospark Switches, Cathode System (MTRDC), Software Packages, Related Infrastructure & Technologies, High-power Microwave Window Technology, Long-life Dispenser Cathodes, 40 kV 3 kA Thyatron, 25 kV 1 kA Thyatron, Design and Technology Development for Gyrotron Devices, 6 MW Pulse 24 kW Average Power S-Band Klystron, 5 MW Pulsed S-band Klystron, 6 Ghz 20 W Helix TWT, 60 W Space TWT, S-band 30 W Helix TWT, Broadband 40 W Mini Helix TWT, C-band 75 kW CC-TWT, 3 MW Pulsed S-Band Magnetron, 2 MW S-band Tunable Pulsed Magnetron, S-band 1 MW Magnetron, S-band 500 kW Magnetron, S-band 400 W Carcinotron
- Ksheer Tester, Ksheer Scanner, Grid-compatible Inverters, 5 kW Solar-power Drive for Pumps, RO Water Plant Automation, Specialised Power Supplies and Pulse Power Systems for High Power Microwave Tubes, Sensor Networks, Wired and Wireless Communication Network for Underground Mines, Electronic Tongue, Electronic Nose, NIR-based Instrumentation for Chemometrics, Electronic Instrumentation for Fresh Water Aqua-culture and RO Systems, Machine Vision Systems for Bakeries and Steel Mills, Machine Vision Systems for On-line Sorting and Grading of Fruit, Monitoring and Control System for Paper and Pulp Industry, Process Control Instrumentation for Sugar Industry, Withering Controls for Tea Processing, Converters/PWM Actuators, High-power ac and dc Drives

Academic Programmes Offered

- The institute conducts post graduate and research programmes under the aegis of AcSIR in Advanced Electronic Systems, Advanced Semiconductor Electronics, and High Power Microwave Devices and Systems Engineering.
- Skill Development Programmes for Students and Working Professionals
- ME/M Tech project work and doctoral thesis work for highly motivated university students in all the above areas of electronics

For Further Details, Please Contact

Director, CSIR - Central Electronics Engineering Research Institute, Pilani (Rajasthan) 333 031
Tel: 91+1596-242111 Fax: 91+1596-242393 E-mail: director@ceeri.res.in www.ceeri.res.in



CSIR-CSIO

Headquarter

Chandigarh

Sector-30 C, Chandigarh-
160030, India
Tel: +91-172-2657190,
Fax: +91-172-2657267
Email: director@csio.res.in

Website: <http://www.csio.res.in>
Follow us at:
<https://www.facebook.com/csiocdg/>

Regional Centre

Chennai

Scientist-in-charge
CSIO, CSIR MADRAS
COMPLEX, Taramani,
Chennai 600113
Tel: 91 44 2254 1061,

Fax: 91 44 2254 1026
Email:
siccsio@csircmc.res.in



CSIR – Central Scientific Instruments Organisation

